

ClubCar®

Owner's Manual

**1992 Carryall-I,
Carryall-II and
Tourall**

Manual Number
1016664
Effective December 1991
1291B1291A

Safety Details:

WARNING:

This instruction manual should be read completely and carefully before attempting to drive or service this vehicle. Failure to follow the instructions in this manual could result in severe personal injury or death.

It is important to note that some statements throughout this manual are preceded by the words **DANGER**, **WARNING**, **CAUTION** or **NOTE**. We recommend that you take special notice of these safety procedures for your protection. Safety procedures are essential and must be followed.

DANGER:

A danger indicates an immediate hazard which will result in severe personal injury or death.

WARNING:

A warning indicates an immediate hazard which could result in severe personal injury or death.

CAUTION:

A caution indicates hazards or unsafe practices which could result in minor personal injury or product or property damage.

NOTE: A note provides key information to make procedures easier or clearer.

The safety procedures listed below must be followed whenever the vehicle is being repaired or serviced. Other specific warnings appear throughout this manual.

WARNING:

Only trained people should repair or service this vehicle. Everyone doing even simple repairs or service should follow the correct procedures and obey the warnings listed in this manual as well as the maintenance and service manual.

Always wear safety glasses or eye protection when servicing the vehicle.

Remove key, place forward and reverse switch in neutral (straight up position) and disconnect batteries before working on vehicle.

Always use insulated tools when working around batteries or electrical connections.

Improper use of this vehicle or the failure to maintain it could result in decreased vehicle performance or severe personal injury.

Follow all procedures listed in manual for loading and unloading vehicle.

Any modification or change to the vehicle which affects the stability or increases the speed beyond the factory specifications could result in severe personal injury or death.

DANGER:

Gasoline/Battery Vapors — Flammable — Explosive — Do not smoke. Keep sparks and flames away from the area of the vehicle. Only service in well-ventilated area.

Engines produce carbon monoxide which is an odorless, deadly poison. **DO NOT OPERATE IN AN ENCLOSED AREA WITHOUT PROPER VENTILATION.**

If any of the warning labels become damaged, have been removed or cannot be easily read, they should be replaced immediately. Contact your CLUB CAR Carryall Dealer.

Front of Vehicle - Electric

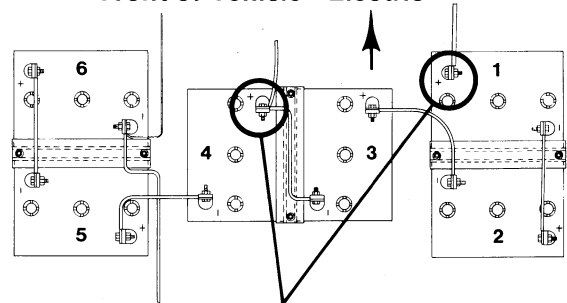

Remove these battery cables before working on Electric vehicle.

TABLE OF CONTENTS

	Page
Safety Details	Inside Front Cover
Foreword	1
Vehicle Feature Identification — Carryall-I Gas	2-3
Vehicle Feature Identification — Carryall-I Electric	4-5
Vehicle Feature Identification — Carryall-II and Carryall-II Plus	6-7
Vehicle Feature Identification — Tourall Gas	8-9
Vehicle Feature Identification — Tourall Electric	10-11
Model Identification	12
Pre-Operation Checklist	12-13
Controls — All Vehicles	13-14
Controls — Carryall-I, Carryall-II and Tourall Gas	14-15
Driving Instructions	15-16
Loading and Unloading — Carryall-I and Carryall-II	17
Towing — Carryall-I and Carryall-II	17
Transporting On A Trailer	18
Storage — Carryall-I, Carryall-II and Tourall Gas	18
Storage — Carryall-I and Tourall Electric	19
Maintenance	20
Periodic Service Schedule	21
Periodic Lubrication Schedule and Lubrication Chart — Carryall-I, Carryall-II and Tourall Gas	22
Engine Oil	22
Periodic Lubrication Schedule and Lubrication Chart — Carryall-I and Tourall Electric	23
Capacities	23
Fueling Instructions — Carryall-I, Carryall-II and Tourall Gas	24
Battery — Carryall-I, Carryall-II and Tourall Gas	24
Jump Starting the Engine — Carryall-I, Carryall-II and Tourall Gas Batteries	25
Batteries — Carryall-I and Tourall Electric	26-27
Battery Charger — Carryall-I and Tourall Electric	27-29
Solid State Controller Vehicle — Carryall-I and Tourall Electric	29
Storage Compartment — Tourall	29
Optional On-Board Charger — Tourall	29
Cleaning	29
Accessories and Options	30
Subsequent Owner Registration	30
Specifications	31
Optional Equipment — Carryall-I	32
Optional Equipment — Carryall-II	33
Warranty	34

Foreword

Congratulations! You have just chosen the finest light utility vehicle on the market today! Several years of the most advanced development, engineering and field experience known to this industry have gone into the manufacture of your CLUB CAR Carryall utility vehicle. With your choice of the Carryall utility vehicle, you have joined a select group of discriminating owners who look for the very best, and who have shown their concern for safety, durability and long-term lasting value. This owner's manual is designed to instruct you, or anyone you may rent or loan your utility vehicle to, in the safe operation of the CLUB CAR Carryall utility vehicle. In addition, this manual will acquaint you with the normal preventive maintenance required in order to provide you safe, optimum vehicle performance.

Your CLUB CAR Carryall Dealer has checked your utility vehicle prior to delivery to you. If any repairs or service need to be performed, except as specified in the Periodic Service Schedule, we advise that they be performed by an authorized CLUB CAR Carryall Dealer or factory representative using only original CLUB CAR parts. Should you require further information, please contact your nearest CLUB CAR Carryall Dealer who can provide you with technical advice, service, replacement parts, or any technical literature available. For the name and address of your nearest CLUB CAR Carryall Dealer, contact CLUB CAR, INC., P. O. Box 204658, Augusta, Georgia 30917-4658, U.S.A., Telephone: 404/863-3000, Technical Services Dept.

The CLUB CAR Carryall utility vehicle Limited Warranty appears on the inside back cover of this manual along with a postage paid warranty registration card for you to complete and mail to CLUB CAR, INC. No other warranties expressed or implied are contained herein.

CLUB CAR, INC., shall not be liable for errors contained herein or for incidental or consequential damages which result from the use of the material in this manual.

This manual should be considered a permanent part of this vehicle. It should stay with the vehicle when sold to provide the next owner with important operating, safety, and maintenance information.

Vehicle Feature Identification

OPERATING INSTRUCTIONS DECAL

OPERATING INSTRUCTIONS

- Read owner's manual prior to operation.
- Study and understand controls. Be sure everyone is seated.
- Before driving, read safety warnings located above pedals.
- Make sure wheels are turned in desired direction.
- Turn key to ON position and be sure nothing is in your path.
- Select direction by placing shift lever in desired position:
F - Forward N - Neutral R - Reverse
- Vehicle will start moving when accelerator is pushed.
- Slowly push accelerator pedal to increase speed. Park brake will release when accelerator pedal is pushed.
- To stop, release accelerator pedal and push brake pedal.
- After stopping, firmly push park brake until it locks.
- Remove key and place shift lever in the straight up neutral position when not in use.

VEHICLE LOADING

- Vehicle rated capacity — 800 lbs. on level surface — See Owner's Manual.
- Maximum cargo bed load — 300 lbs.
- Avoid stopping on or backing down steep hills when fully loaded.
- Do not load tailgate.
- Cargo should be evenly spread over the floor of cargo bed as far forward as possible.
- Secure loads to prevent load shifting.
- For vehicle stability, drive slowly when loaded and avoid top heavy loads. The center of gravity of load must not exceed 15 inches above cargo bed bottom.
- Maximum trailer hitch tongue weight — 150 lbs.

WARNING
Keep hands, body and other persons away when closing bed

BED LATCH DECAL (ON BODY UNDER BED LATCH HANDLE)

WARNING

Pinch point

PINCH WARNING DECAL (ON SEAT BACK SUPPORT)

OIL WARNING LIGHT

BRAKE PEDAL

VEHICLE LOADING LABEL

ON-OFF LABEL (UNDER KEY SWITCH)



TILT BED WARNING DECAL

WARNING

No persons in cargo bed

ACCELERATOR PEDAL

SERIAL NUMBER

SAFETY WARNING LABEL

<p>WARNING</p> <p>Failure To Follow These Instructions Can Cause Severe Injury Or Death.</p>	<ul style="list-style-type: none"> • Read Operating Instructions Before Using Vehicle. • Never Stand In Front Of Or Behind Vehicle. • Vehicle Should Be Driven Only In Specified Areas By Trained Persons. 	<ul style="list-style-type: none"> • Do Not Use On Public Roads. • Only Two Persons Per Seat. • Operate Vehicle From Drivers Side Only • Do Not Start Vehicle Until All People Are Seated. 	<ul style="list-style-type: none"> • Remain Seated & Hold On in Moving Vehicle. • Keep Arms, Legs, Feet & Body Inside Vehicle. • Stop Vehicle Before Changing Direction. Buzzer Will Sound in Reverse. • Drive Slowly in Turns. 	<ul style="list-style-type: none"> • Drive Slowly Straight Up & Down Slopes. • Set Park Brake Before Leaving Vehicle. • Remove Key When Vehicle is Not In Use. • Place Shift Lever in Neutral When Vehicle is Not In Use.
---	---	--	---	---

Carryall-I Gasoline

PERIODIC SERVICE SCHEDULE (ON INTAKE BOX)

ClubCar®

Checking Engine Oil Level

Periodic Service Schedule:

Service	Regular Interval
1. Check Oil Level	Monthly
2. Oil and Filter Change	*Two Years or 300 Hours
3. Check Condition & Clean Air Filter Element	One Year Under Normal Use Six Months Under Dusty Conditions
4. Change Air Filter	*Two Years or 300 Hours
5. Check Tire Pressure (32-34 psi)	Monthly
6. Replace Fuel Filters	*Two Years or 300 Hours
7. Check/Fill Drive Unit	*One Year or 150 Hours
8. Check/Fill Transmission	*One Year or 150 Hours

WARNING

Governor is factory adjusted for 12-14 mph max. Do not tamper with adjustment. To do so: 1) will void the warranty; 2) may result in damage to the engine or components; 3) could result in severe personal injury.

SAE 30 above 32°F (0°C) or SAE 5W20 below 32°F (0°C)
Classification SF, SE or SD
* Whichever comes first.

Shield Eyes **Contains Sulfuric Acid** **POISON** • **DANGER**

- In event of accident flush with water and call a physician.
- CAUSES SEVERE BURNS** - Avoid contact with skin, eyes or clothing. **KEEP OUT OF REACH OF CHILDREN**

Explosive Gas **Avoid Spark/Flame**

- Charge in well ventilated areas only. Do not charge, service or adjust battery post connections without proper instruction and training.
- Cigarettes, flames or sparks could cause battery to explode.

BATTERY DANGER LABEL (ON BODY)

FORWARD-REVERSE LEVER



CHOKE

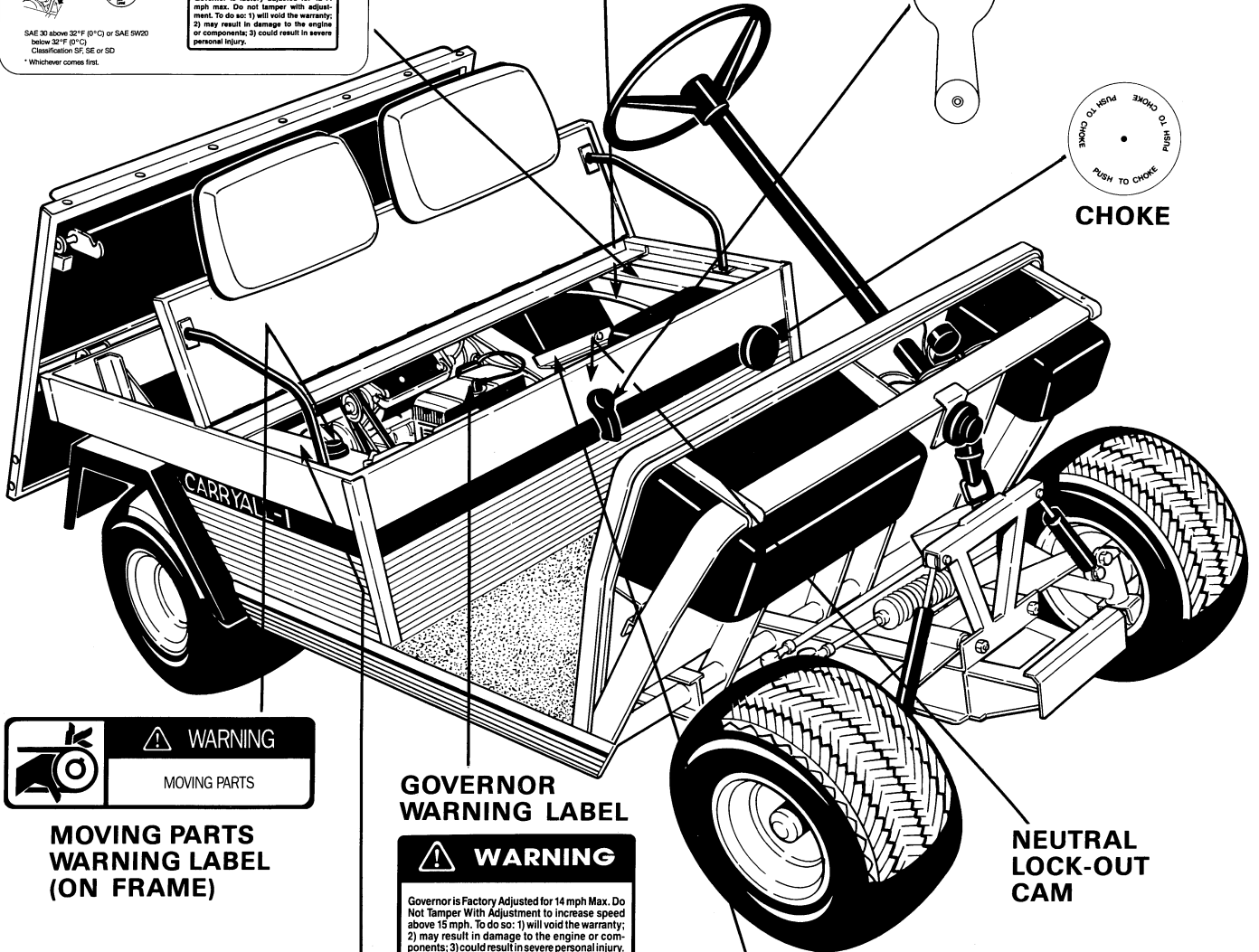

WARNING **MOVING PARTS**

MOVING PARTS WARNING LABEL (ON FRAME)

GOVERNOR WARNING LABEL

WARNING

Governor is Factory Adjusted for 14 mph Max. Do Not Tamper With Adjustment to increase speed above 15 mph. To do so: 1) will void the warranty; 2) may result in damage to the engine or components; 3) could result in severe personal injury.

NEUTRAL LOCK-OUT CAM

GASOLINE TANK DANGER LABEL (ON FRAME)

DANGER

- Gasoline — Extremely Flammable.
- Keep Heat, Sparks And Open Flame Away From Fuel Tank And Fuel Lines
- Do Not Add Fuel While Engine Is Running Or Hot.
- Service By Trained Personnel.

WARNING

Negative Frame Ground. Do Not Contact Positive (+) Battery Post Or Cable To Frame As This Can Cause Battery Explosion, Electrical Shocks, And Burns.

FRAME GROUND WARNING LABEL (ON FRAME)

Vehicle Feature Identification

OPERATING INSTRUCTIONS DECAL

OPERATING INSTRUCTIONS

- Read owner's manual prior to operation.
- Study and understand controls. Be sure everyone is seated.
- Before driving, read safety warnings located above pedals.
- Make sure wheels are turned in desired direction.
- Turn key to ON position and be sure nothing is in your path.
- Select direction by placing shift lever in desired position:
F - Forward N - Neutral R - Reverse
- Vehicle will start moving when accelerator is pushed.
- Slowly push accelerator pedal to increase speed. Park brake will release when accelerator pedal is pushed.
- To stop, release accelerator pedal and push brake pedal.
- After stopping, firmly push park brake until it locks.
- Remove key and place shift lever in the straight up neutral position when not in use.

VEHICLE LOADING

- Vehicle rated capacity — 800 lbs. on level surface — See Owner's Manual.
- Maximum cargo bed load — 300 lbs.
- Avoid stopping on or backing down steep hills when fully loaded.
- Do not load tailgate.
- Cargo should be evenly spread over the floor of cargo bed as far forward as possible.
- Secure loads to prevent load shifting.
- For vehicle stability, drive slowly when loaded and avoid top heavy loads. The center of gravity of load must not exceed 15 inches above cargo bed bottom.
- Maximum trailer hitch tongue weight — 150 lbs.

WARNING
Keep hands, body and other persons away when closing bed

**LATCH DECAL
(ON BODY UNDER
BED LATCH HANDLE)**

WARNING
**No persons
in cargo bed**

**TILT BED
WARNING DECAL**

**VEHICLE LOADING
LABEL**

**ACCELERATOR
PEDAL**

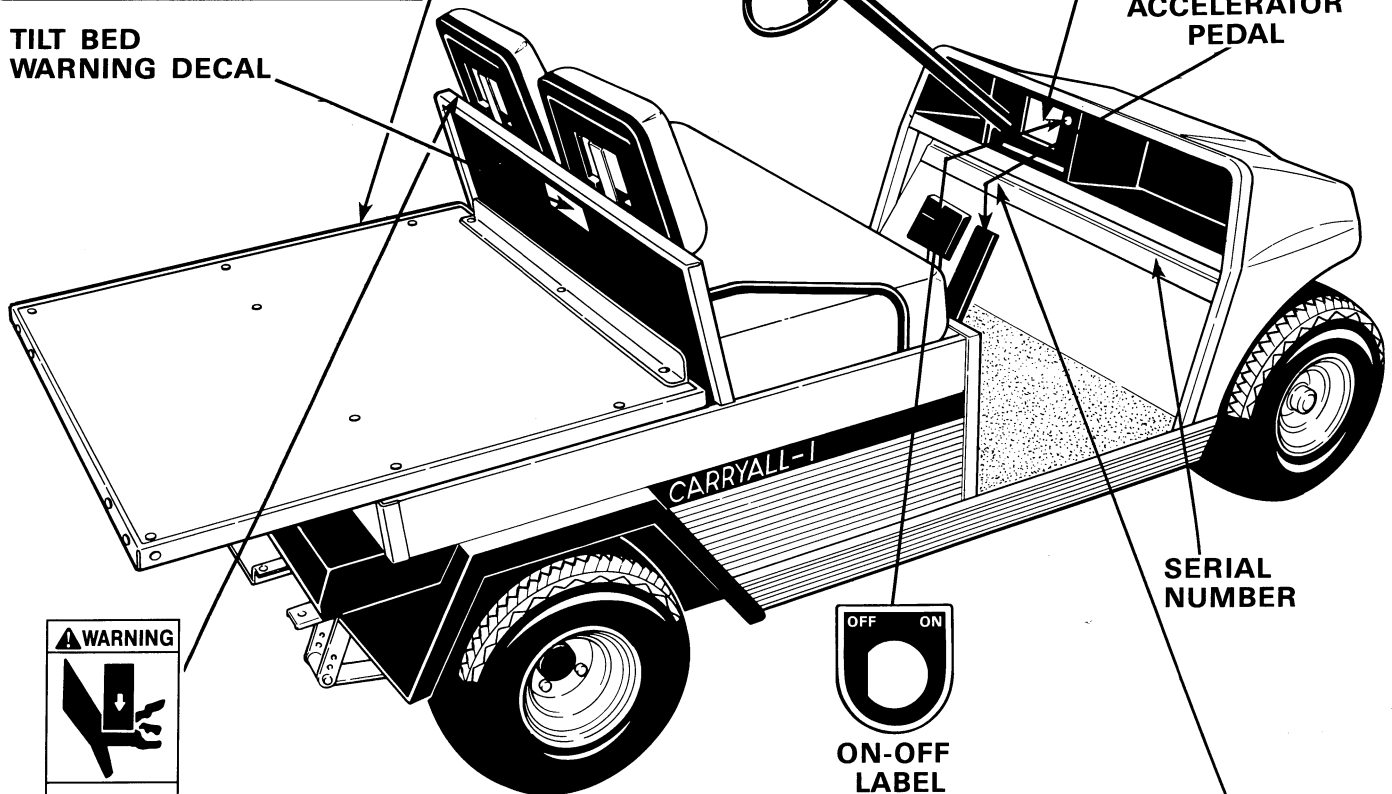

**ON-OFF
LABEL
(UNDER KEY SWITCH)**

**SERIAL
NUMBER**

**SAFETY WARNING
LABEL**

WARNING
**Pinch
point**

**PINCH WARNING DECAL
(ON SEAT BACK SUPPORT)**

WARNING
Failure To Follow These Instructions Can Cause Severe Injury Or Death.

- Read Operating Instructions Before Using Vehicle.
- Never Stand In Front Of Or Behind Vehicle.
- Vehicle Should Be Driven Only In Specified Areas By Trained Persons.
- Do Not Use On Public Roads.
- Only Two Persons Per Seat.
- Operate Vehicle From Drivers Side Only
- Do Not Start Vehicle Until All People Are Seated.
- Remain Seated & Hold On In Moving Vehicle.
- Keep Arms, Legs, Feet & Body Inside Vehicle.
- Stop Vehicle Before Changing Direction. Buzzer Will Sound In Reverse.
- Drive Slowly In Turns.
- Drive Slowly Straight Up & Down Slopes.
- Set Park Brake Before Leaving Vehicle.
- Remove Key When Vehicle Is Not In Use.
- Place Shift Lever In Neutral When Vehicle Is Not In Use.

Carryall-I Electric

RESISTOR
WARNING LABEL (ON BODY)

! WARNING HOT RESISTORS CAN CAUSE SEVERE BURNS.

SPEED SWITCH CAUTION LABEL

CAUTION !

- DO NOT OPERATE VEHICLE WITHOUT COVER IN PLACE.
- DO NOT DIRECT WATER STREAM AT THIS SWITCH.

FUSE LINK

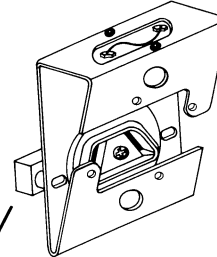

CHARGER RECEPTACLE

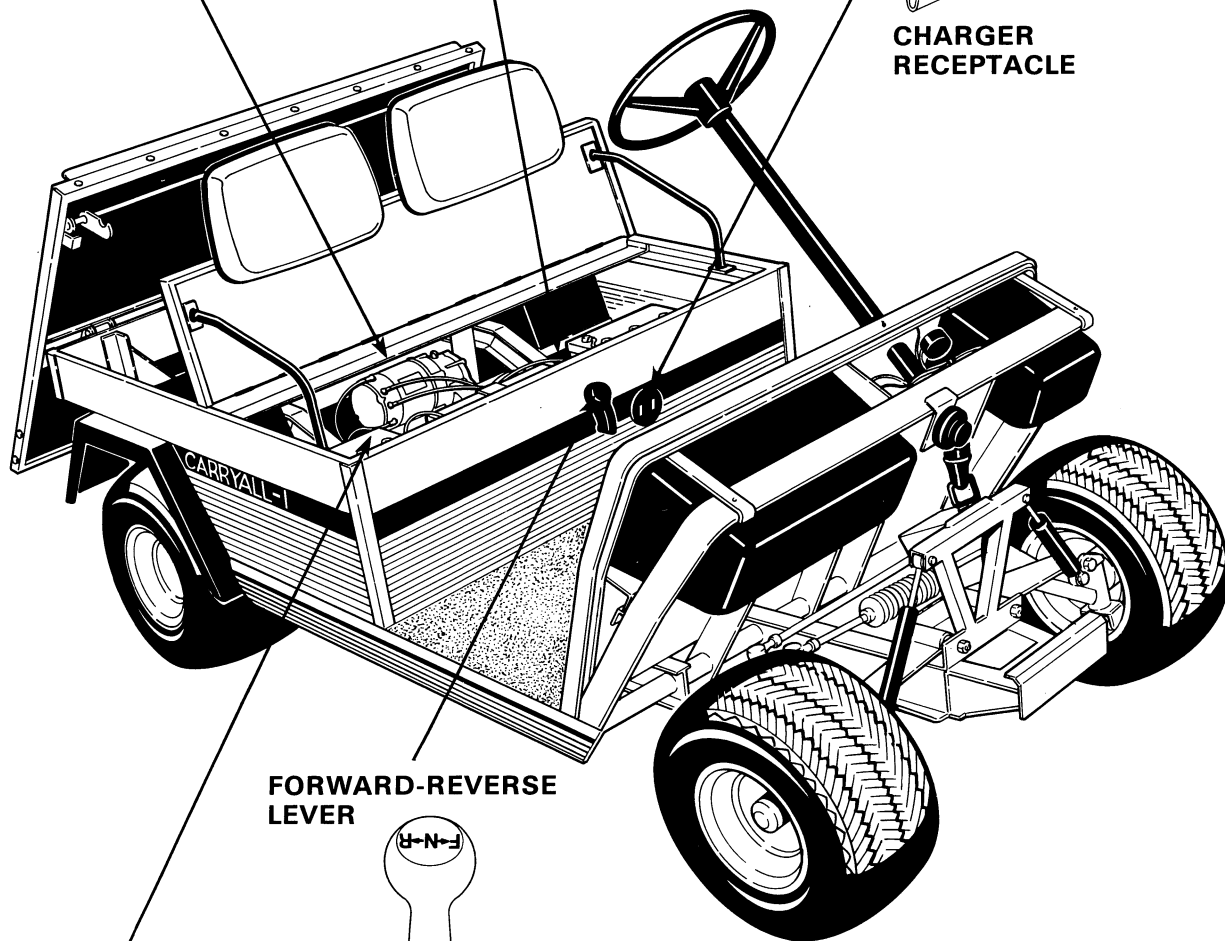

FORWARD-REVERSE LEVER

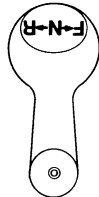

DANGER LABEL (ON BODY)

Shield Eyes Contains Sulfuric Acid		POISON • DANGER
Explosive Gas		<ul style="list-style-type: none"> • In event of accident flush with water and call a physician. • CAUSES SEVERE BURNS - Avoid contact with skin, eyes or clothing. KEEP OUT OF REACH OF CHILDREN • Charge in well ventilated areas only. Do not charge, service or adjust battery post connections without proper instruction and training. • Cigarettes, flames or sparks could cause battery to explode.
Avoid Spark/Flame		

Vehicle Feature Identification

OPERATING INSTRUCTIONS LABEL

VEHICLE LOADING

- Vehicle rated capacity — 1200 lbs. on level surface — See Owner's Manual.
- Maximum cargo bed load — 800 lbs.
- Avoid stopping on or backing down steep hills when fully loaded.
- Do not load tailgate.
- Cargo should be evenly spread over the floor of cargo bed as far forward as possible.
- Secure loads to prevent load shifting.
- For vehicle stability, drive slowly when loaded and avoid top heavy loads. The center of gravity of load must not exceed 15 inches above cargo bed bottom.
- Maximum trailer hitch tongue weight — 150 lbs.

VEHICLE LOADING LABEL



ON-OFF LABEL (UNDER KEY SWITCH)

OPERATING INSTRUCTIONS

- Read owner's manual prior to operation.
- Study and understand controls. Be sure everyone is seated.
- Before driving, read safety warnings located above pedals.
- Make sure wheels are turned in desired direction.
- Turn key to ON position and be sure nothing is in your path.
- Select direction by placing shift lever in desired position:
F - Forward N - Neutral R - Reverse
- Vehicle will start moving when accelerator is pushed.
- Slowly push accelerator pedal to increase speed. Park brake will release when accelerator pedal is pushed.
- To stop, release accelerator pedal and push brake pedal.
- After stopping, firmly push park brake until it locks.
- Remove key and place shift lever in the straight up neutral position when not in use.

WARNING

No persons in cargo bed

TILT BED WARNING DECAL

OIL WARNING LIGHT

PARK BRAKE PEDAL

BRAKE PEDAL

ACCELERATOR PEDAL

BED LATCH

SERIAL NUMBER

LATCH DECAL (ON BODY)

WARNING
Keep hands, body and other persons away when closing bed

PINCH WARNING DECAL (ON SEAT BACK SUPPORT)

WARNING

Pinch point

SAFETY WARNING LABEL

<p>WARNING</p> <p>Failure to Follow These Instructions Can Cause Severe Injury Or Death.</p>	<ul style="list-style-type: none"> • Read Operating Instructions Before Using Vehicle. • Never Stand In Front Of Or Behind Vehicle. • Vehicle Should Be Driven Only In Specified Areas By Trained Persons. 	<ul style="list-style-type: none"> • Do Not Use On Public Roads. • Only Two Persons Per Seat. • Operate Vehicle From Drivers Side Only • Do Not Start Vehicle Until All People Are Seated. 	<ul style="list-style-type: none"> • Remain Seated & Hold On In Moving Vehicle. • Keep Arms, Legs, Feet & Body Inside Vehicle. • Stop Vehicle Before Changing Direction. Buzzer Will Sound In Reverse. • Drive Slowly In Turns. 	<ul style="list-style-type: none"> • Drive Slowly Straight Up & Down Slopes. • Set Park Brake Before Leaving Vehicle. • Remove Key When Vehicle Is Not In Use. • Place Shift Lever In Neutral When Vehicle Is Not In Use.
---	---	--	---	---

Carryall-II and Carryall-II Plus

PERIODIC SERVICE SCHEDULE (ON INTAKE BOX)

ClubCar®

Periodic Service Schedule:

Service	Regular Interval
1. Check Oil Level	Monthly
2. Oil and Filter Change	*Two Years or 300 Hours
3. Check Condition & Clean Air Filter Element	One Year Under Normal Use Six Months Under Dusty Conditions
4. Change Air Filter	*Two Years or 300 Hours
5. Check Tire Pressure (15-14 PSI)	Monthly
6. Replace Fuel Filters	*Two Years or 300 Hours
7. Check/Fill Drive Unit	*One Year or 150 Hours
8. Check/Fill Transmission	*One Year or 150 Hours

WARNING

Governor is factory adjusted for 12-14 mph max. Do not tamper with adjustment. To do so: 1) will void the warranty; 2) may result in damage to the engine or components; 3) could result in severe personal injury.

SAE 30 above 32°F (0°C) or SAE 5W20 below 32°F (0°C)
Classification SF, SE or SD
* Whichever comes first.

FORWARD-REVERSE LEVER



DANGER

- Gasoline — Extremely Flammable.
- Keep Heat, Sparks And Open Flame Away From Fuel Tank And Fuel Lines
- Do Not Add Fuel While Engine Is Running Or Hot.
- Service By Trained Personnel.

GASOLINE TANK DANGER LABEL (ON FRAME)

WARNING

MOVING PARTS

MOVING PARTS WARNING LABEL

FILL LABEL (UNDER FUEL CAP)

BED LATCH

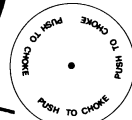
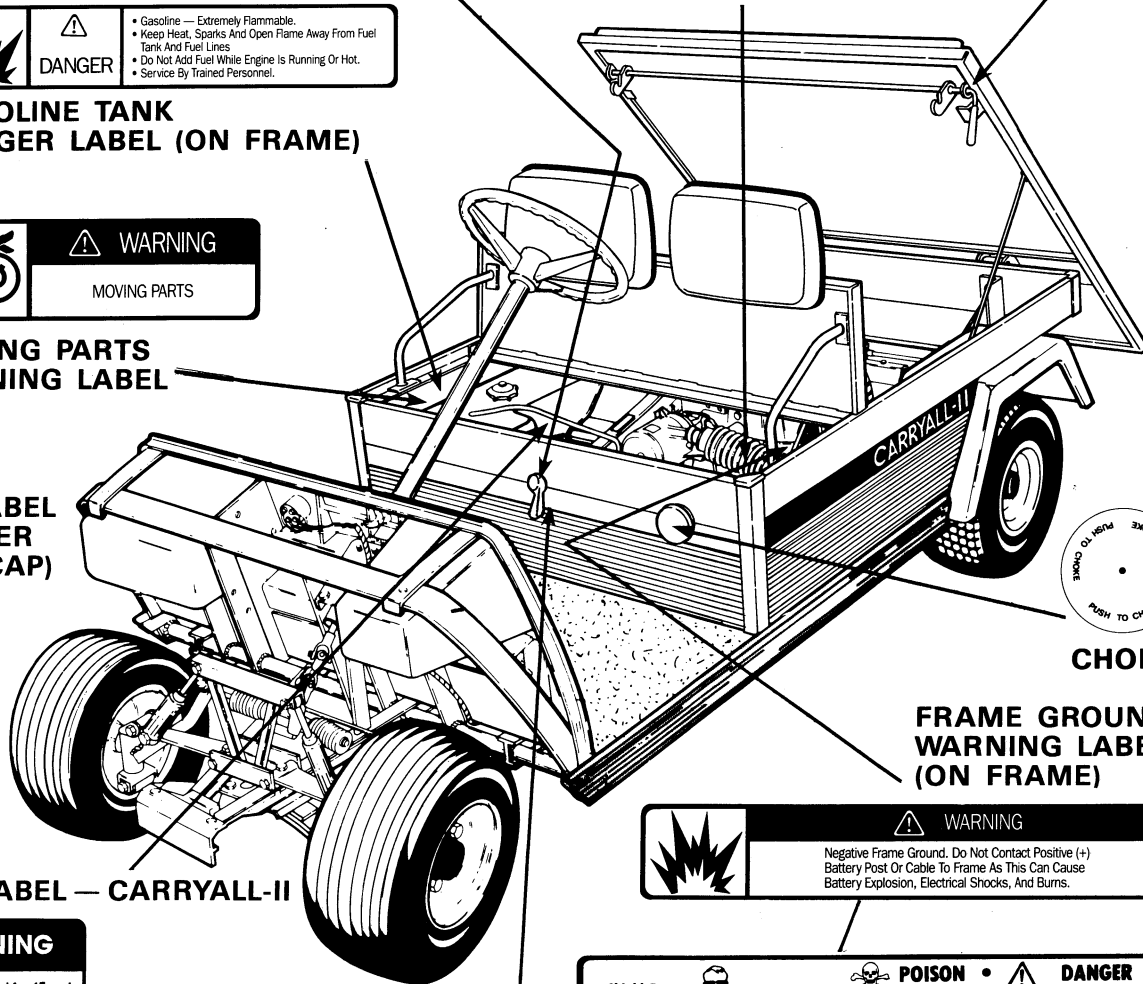

CHOKE

FRAME GROUND WARNING LABEL (ON FRAME)

WARNING

Negative Frame Ground. Do Not Contact Positive (+) Battery Post Or Cable To Frame As This Can Cause Battery Explosion, Electrical Shocks, And Burns.

GOVERNOR WARNING LABEL — CARRYALL-II

WARNING

Governor is Factory Adjusted for 15 mph Max. Do Not Tamper With Adjustment to increase speed above 16 mph. To do so: 1) will void the warranty; 2) may result in damage to the engine or components; 3) could result in severe personal injury.

NEUTRAL LOCK-OUT CAM

POISON • DANGER

Shield Eyes Contains Sulfuric Acid

- In event of accident flush with water and call a physician.
- CAUSES SEVERE BURNS - Avoid contact with skin, eyes or clothing. KEEP OUT OF REACH OF CHILDREN

Explosive Gas

Avoid Spark/Flame

- Charge in well ventilated areas only. Do not charge, service or adjust battery post connections without proper instruction and training.
- Cigarettes, flames or sparks could cause battery to explode.

BATTERY DANGER LABEL (ON BODY)

GOVERNOR WARNING LABEL — CARRYALL-II PLUS

WARNING

Governor is Factory Adjusted for 17-18 mph Max. Do Not Tamper With Adjustment. To do so: 1) will void the warranty; 2) may result in damage to the engine or components; 3) could result in severe personal injury.

461 Mainifold

Vehicle Feature Identification

OPERATING INSTRUCTIONS DECAL

OPERATING INSTRUCTIONS

- Read owner's manual prior to operation.
- Study and understand controls. Be sure everyone is seated.
- Before driving, read safety warnings located above pedals.
- Make sure wheels are turned in desired direction.
- Turn key to ON position and be sure nothing is in your path.
- Select direction by placing shift lever in desired position:
F - Forward N - Neutral R - Reverse
- Vehicle will start moving when accelerator is pushed.
- Slowly push accelerator pedal to increase speed. Park brake will release when accelerator pedal is pushed.
- To stop, release accelerator pedal and push brake pedal.
- After stopping, firmly push park brake until it locks.
- Remove key and place shift lever in the straight up neutral position when not in use.

PASSENGER WARNING LABEL

WARNING

- No more than four persons should be on the vehicle at one time.
- Passengers should remain seated and hold onto seat handle or handrail at all times.
- Stop vehicle before shifting forward and reverse lever. Failure to do so could result in injury to passengers and damage to vehicle.
- Slower speeds should be observed when transporting passengers.



**ON-OFF LABEL
(UNDER KEY SWITCH)**

**OIL WARNING
LIGHT**

**PARKING
BRAKE
PEDAL**

**BRAKE
PEDAL**

SEAT HANDLES

HANDRAIL

**SERIAL
NUMBER**

**ACCELERATOR
PEDAL**

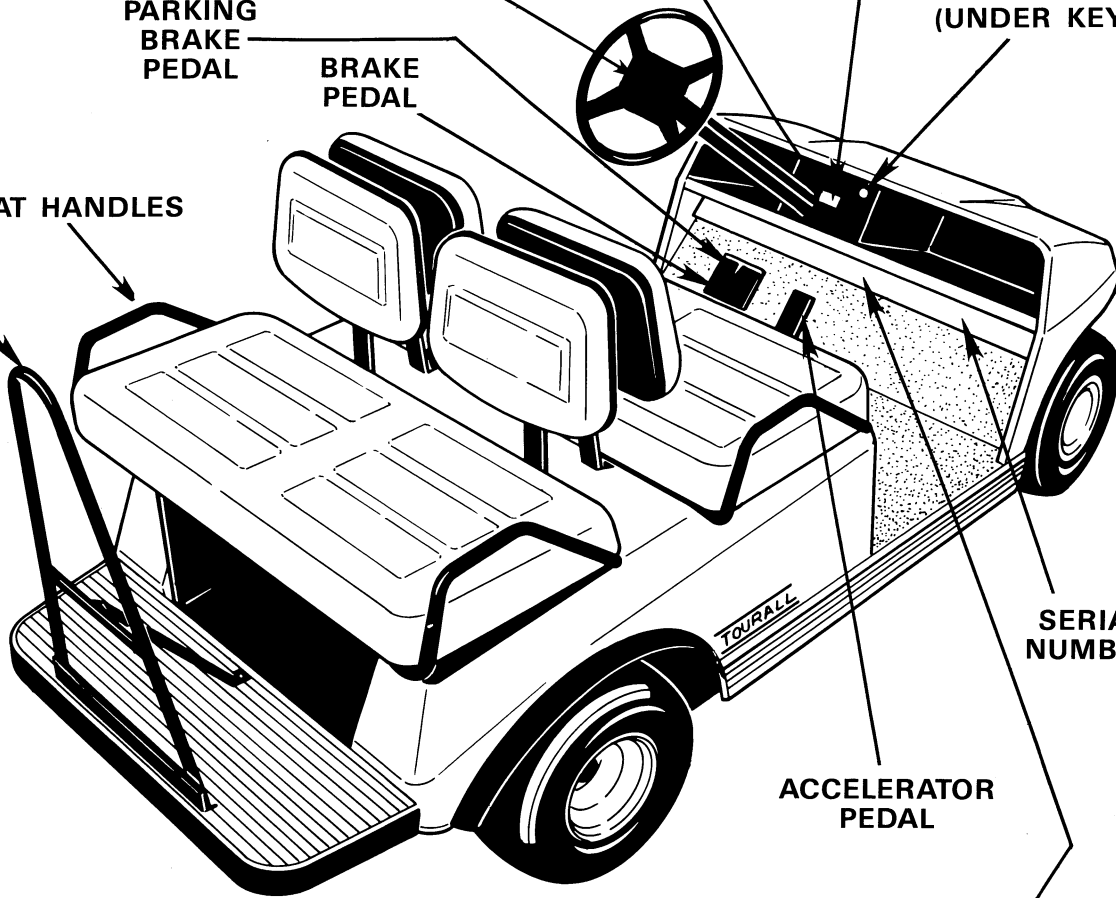

SAFETY WARNING LABEL

<p>WARNING Failure To Follow These Instructions Can Cause Severe Injury Or Death.</p>	<ul style="list-style-type: none"> • Read Operating Instructions Before Using Vehicle. • Never Stand In Front Of Or Behind Vehicle. • Vehicle Should Be Driven Only In Specified Areas By Trained Persons. 	<ul style="list-style-type: none"> • Do Not Use On Public Roads. • Only Two Persons Per Seat. • Operate Vehicle From Drivers Side Only • Do Not Start Vehicle Until All People Are Seated. 	<ul style="list-style-type: none"> • Remain Seated & Hold On In Moving Vehicle. • Keep Arms, Legs, Feet & Body Inside Vehicle. • Stop Vehicle Before Changing Direction. • Buzzer Will Sound In Reverse. • Drive Slowly In Turns. 	<ul style="list-style-type: none"> • Drive Slowly Straight Up & Down Slopes. • Set Park Brake Before Leaving Vehicle. • Remove Key When Vehicle Is Not In Use. • Place Shift Lever In Neutral When Vehicle Is Not In Use.

Tourall Gasoline

HOT MANIFOLD AND MUFFLER LABEL (ON BODY)

WARNING HOT manifold and muffler can cause severe burns.

GASOLINE TANK DANGER LABEL (ON BODY)



	DANGER	<ul style="list-style-type: none"> Gasoline — Extremely Flammable. Keep Heat, Sparks And Open Flame Away From Fuel Tank And Fuel Lines Do Not Add Fuel While Engine Is Running Or Hot. Service By Trained Personnel.
---	---------------	--

MOVING PARTS DECAL (ON FRAME)

	WARNING
MOVING PARTS	

OIL FILL

PERIODIC SERVICE SCHEDULE (ON INTAKE BOX)

ClubCar ®		Periodic Service Schedule:																		
Checking Engine Oil Level		<table border="1"> <tr> <th>Service</th> <th>Regular Interval</th> </tr> <tr> <td>1. Check Oil Level</td> <td>Monthly</td> </tr> <tr> <td>2. Oil and Filter Change</td> <td>*Two Years or 300 Hours</td> </tr> <tr> <td>3. Check Condition & Clean Air Filter Element</td> <td>One Year Under Normal Use Six Months Under Dually Conditions</td> </tr> <tr> <td>4. Change Air Filter</td> <td>*Two Years or 300 Hours</td> </tr> <tr> <td>5. Check Tire Pressure (12-14 psi)</td> <td>Monthly</td> </tr> <tr> <td>6. Replace Fuel Filters</td> <td>*Two Years or 300 Hours</td> </tr> <tr> <td>7. Check/Fill Drive Unit</td> <td>*One Year or 150 Hours</td> </tr> <tr> <td>8. Check/Fill Transmission</td> <td>*One Year or 150 Hours</td> </tr> </table>	Service	Regular Interval	1. Check Oil Level	Monthly	2. Oil and Filter Change	*Two Years or 300 Hours	3. Check Condition & Clean Air Filter Element	One Year Under Normal Use Six Months Under Dually Conditions	4. Change Air Filter	*Two Years or 300 Hours	5. Check Tire Pressure (12-14 psi)	Monthly	6. Replace Fuel Filters	*Two Years or 300 Hours	7. Check/Fill Drive Unit	*One Year or 150 Hours	8. Check/Fill Transmission	*One Year or 150 Hours
Service	Regular Interval																			
1. Check Oil Level	Monthly																			
2. Oil and Filter Change	*Two Years or 300 Hours																			
3. Check Condition & Clean Air Filter Element	One Year Under Normal Use Six Months Under Dually Conditions																			
4. Change Air Filter	*Two Years or 300 Hours																			
5. Check Tire Pressure (12-14 psi)	Monthly																			
6. Replace Fuel Filters	*Two Years or 300 Hours																			
7. Check/Fill Drive Unit	*One Year or 150 Hours																			
8. Check/Fill Transmission	*One Year or 150 Hours																			
  		<p>WARNING</p> <p>Governor is factory adjusted for 12-14 mph max. Do not tamper with adjustment. To do so: 1) will void the warranty; 2) may result in damage to engine or components; 3) could result in severe personal injury.</p>																		
<p>SAE 30 above 32°F (0°C) or SAE 5W20 below 32°F (0°C) Classification SF, SE or SD * Whichever comes first.</p>																				

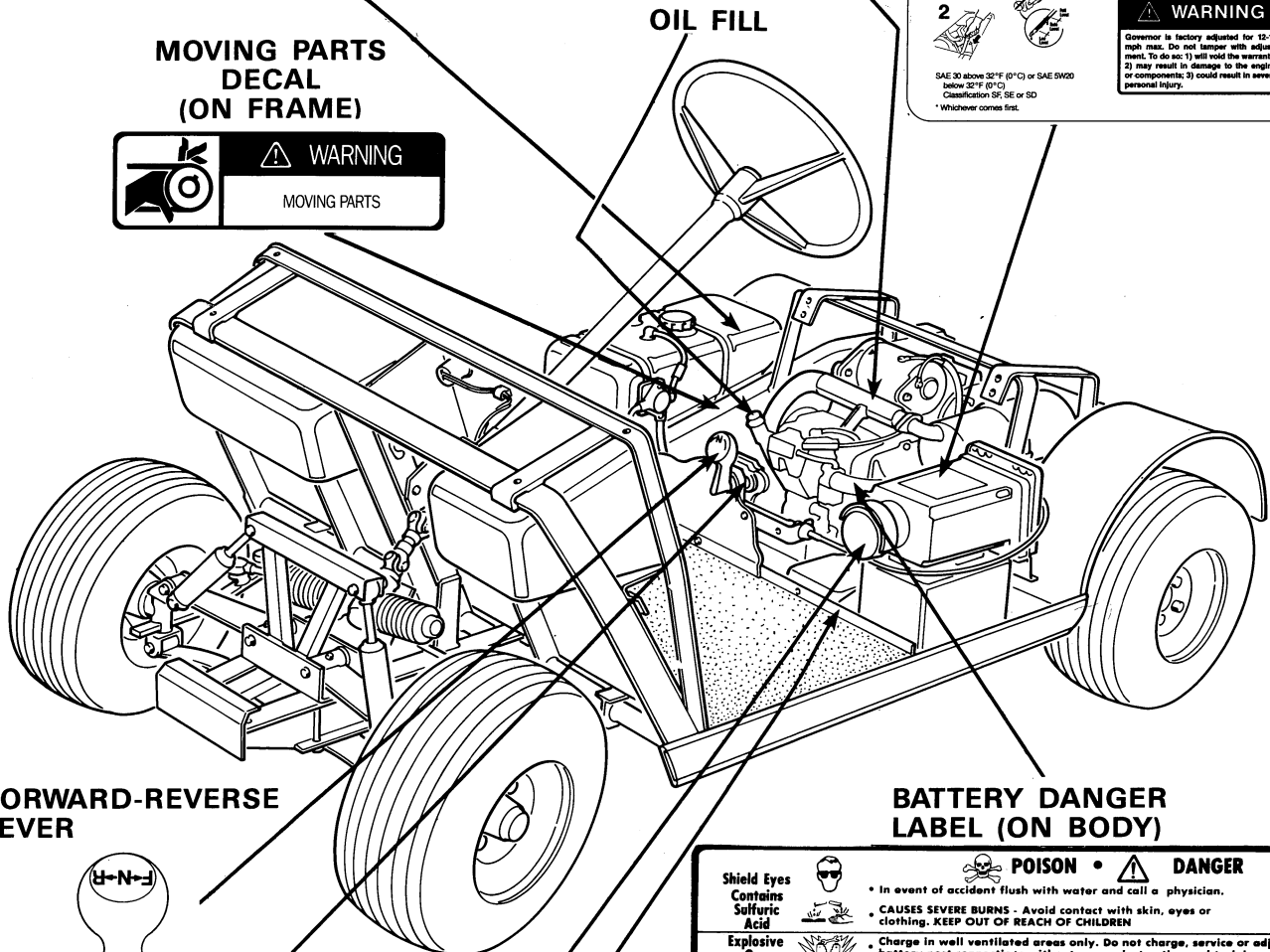

FORWARD-REVERSE LEVER

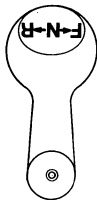

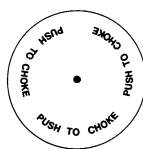

CHOKE



NEUTRAL LOCK-OUT CAM

BATTERY DANGER LABEL (ON BODY)

Shield Eyes Contains Sulfuric Acid		POISON • DANGER
Explosive Gas		<ul style="list-style-type: none"> In event of accident flush with water and call a physician. CAUSES SEVERE BURNS - Avoid contact with skin, eyes or clothing. KEEP OUT OF REACH OF CHILDREN Charge in well ventilated areas only. Do not charge, service or adjust battery post connections without proper instruction and training. Cigarettes, flames or sparks could cause battery to explode.
Avoid Spark/Flame		

FRAME GROUND WARNING LABEL (ON FRAME)

	WARNING
Negative Frame Ground. Do Not Contact Positive (+) Battery Post Or Cable To Frame As This Can Cause Battery Explosion, Electrical Shocks, And Burns.	

Vehicle Feature Identification

OPERATING INSTRUCTIONS DECAL

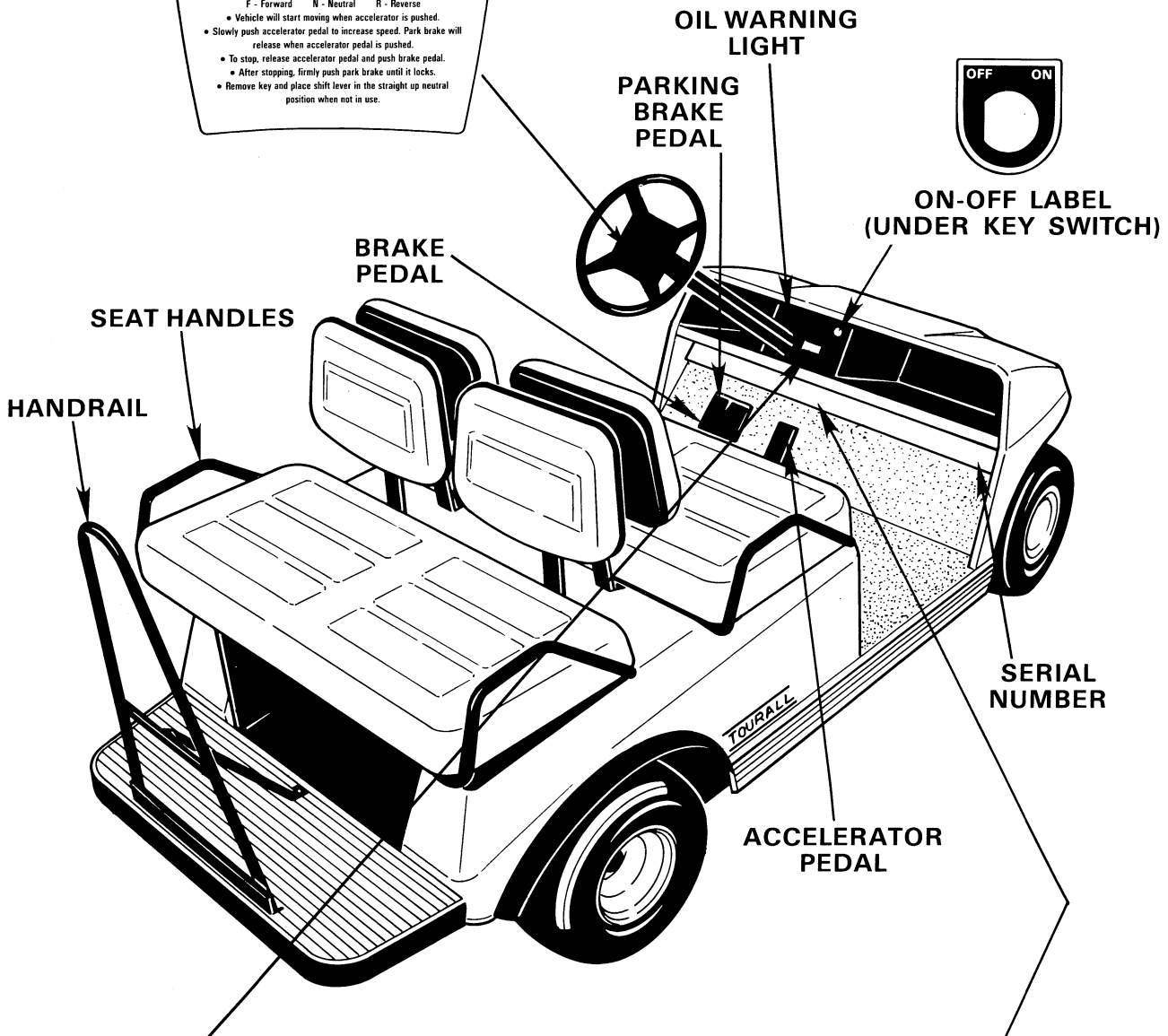
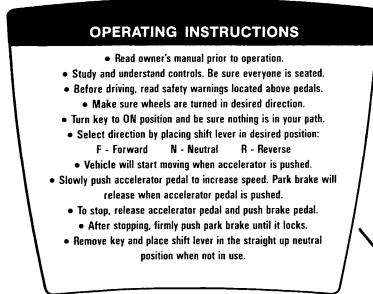

PASSENGER WARNING LABEL

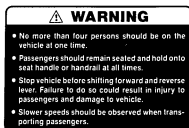





SAFETY WARNING LABEL

<p>WARNING</p> <p>Failure To Follow These Instructions Can Cause Severe Injury Or Death.</p>	<ul style="list-style-type: none"> • Read Operating Instructions Before Using Vehicle. • Never Stand In Front Of Or Behind Vehicle. • Vehicle Should Be Driven Only In Specified Areas By Trained Persons. 	<ul style="list-style-type: none"> • Do Not Use On Public Roads. • Only Two Persons Per Seat. • Operate Vehicle From Drivers Side Only • Do Not Start Vehicle Until All People Are Seated. 	<ul style="list-style-type: none"> • Remain Seated & Hold On In Moving Vehicle. • Keep Arms, Legs, Feet & Body Inside Vehicle. • Stop Vehicle Before Changing Direction. Buzzer Will Sound In Reverse. • Drive Slowly In Turns. 	<ul style="list-style-type: none"> • Drive Slowly Straight Up & Down Slopes. • Set Park Brake Before Leaving Vehicle. • Remove Key When Vehicle Is Not In Use. • Place Shift Lever In Neutral When Vehicle Is Not In Use.
---	---	--	---	---

Tourall Electric

DANGER LABEL (ON BODY)

Shield Eyes Contains Sulfuric Acid		POISON •  DANGER
Explosive Gas		• In event of accident flush with water and call a physician. • CAUSES SEVERE BURNS - Avoid contact with skin, eyes or clothing. KEEP OUT OF REACH OF CHILDREN
Avoid Spark/Flame		• Charge in well ventilated areas only. Do not charge, service or adjust battery post connections without proper instruction and training. • Cigarettes, flames or sparks could cause battery to explode.

SPEED SWITCH CAUTION LABEL

CAUTION	• DO NOT OPERATE VEHICLE WITHOUT COVER IN PLACE. • DO NOT DIRECT WATER STREAM AT THIS SWITCH.
	

FUSE LINK

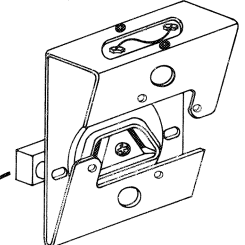

CHARGER RECEPTACLE

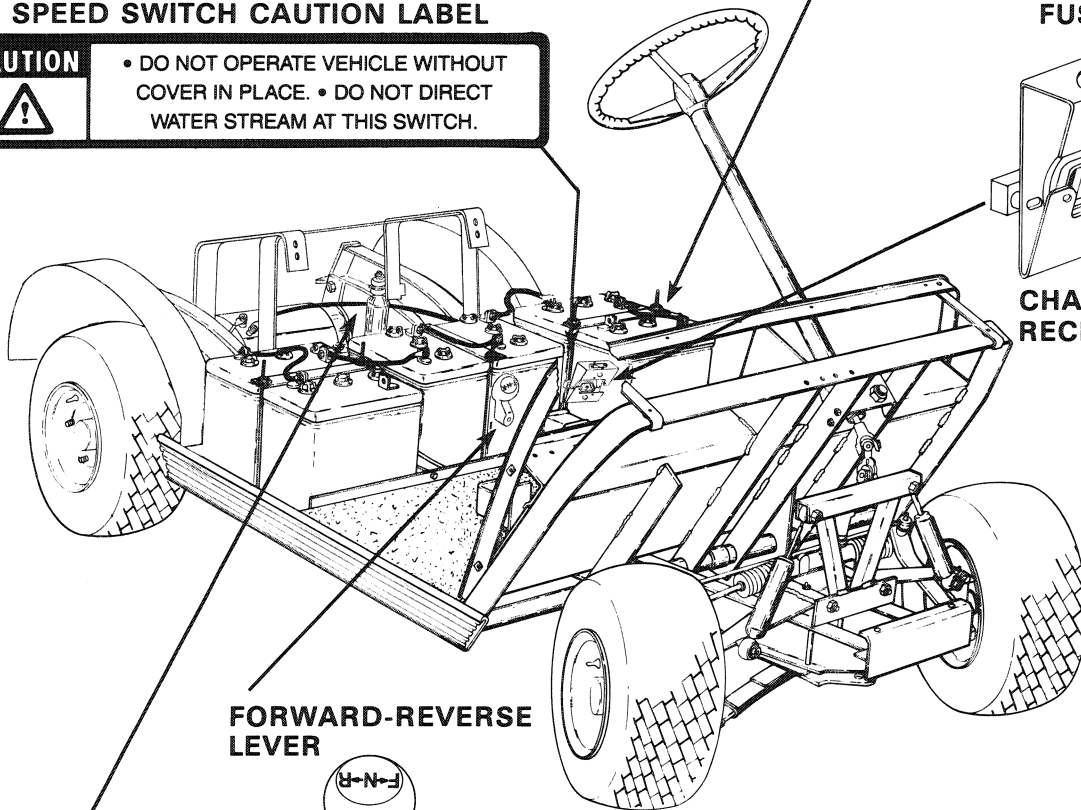

FORWARD-REVERSE LEVER



RESISTOR WARNING LABEL (ON BODY)

	WARNING	HOT RESISTORS CAN CAUSE SEVERE BURNS.
---	----------------	--

Model Identification:

The serial number of your Carryall or Tourall is stamped on a data plate mounted on the frame directly under the right dash (Example: EG9202-123456, FG9202-123456, F9202-123456, T9202-123456, or TG9202-123456).

NOTE: Always mention this number when ordering parts or making inquiries (See Figure 1).

Pre-Operation Checklist:

Your Carryall or Tourall has been thoroughly inspected and adjusted at the factory and by your CLUB CAR Carryall Dealer. However, when receiving your new Carryall or Tourall you should become familiar with its controls and operation and carefully inspect each vehicle to be satisfied with its condition before accepting delivery.

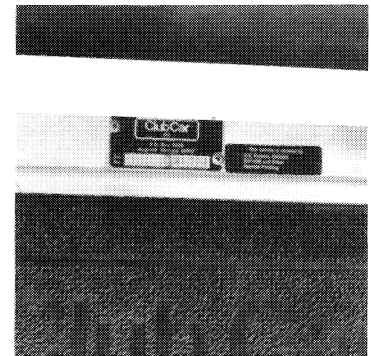

Figure 1

WARNING:

Only trained people should repair or service this vehicle. Everyone doing even simple repairs or service should follow the correct procedures and obey the warnings listed in this manual as well as the maintenance and service manual.

Always wear safety glasses or eye protection when servicing the vehicle.

Use this checklist as a guide to inspect your new vehicle. Any problems must be corrected only by your CLUB CAR Carryall Dealer or a trained mechanic.

Visual Inspection - Look for the following on your vehicle:

General:

All parts should be in place and properly installed. Be sure that all nuts, bolts and screws are tight. All hose clamps should be tight. Check the starter belt for tightness.

Warning Labels:

Check that all warning and operation labels are in place (See Pages 2-11).

Tires:

Check tire pressure. It should be 12-14 psi. It should be increased to 18 psi for heavy loads.

Engine — Carryall/Tourall Gas:

Check for proper engine oil level (See Page 22). Be sure spark plug wire is in clamp on top of engine.

Fuel — Carryall/Tourall Gas:

Check fuel level (See Fueling Instructions - Page 24).

Batteries — Carryall/Tourall Electric:

Check the electrolyte to insure if it is at its proper level (See Page 26). Check the battery posts for corrosion. Check all electrical wires for tightness or damage.

CAUTION:

Be sure the plastic has been removed from the bottom of the seat before operating vehicle. Failure to do so may result in a fire or property damage.

Performance Inspection - After you have familiarized yourself with the vehicle's controls (See Page 13) and have read and understood the driving instructions (See Page 15), take the vehicle for a test drive. Check the following:

Brakes:

Be sure that the brakes work properly. Both rear wheels should brake properly and the pedal should not go more than halfway to the floor. If it does, have brakes adjusted.

Park Brake:

The park brake should lock the wheels when latched and should release when the accelerator or brake pedal is pushed.

Steering:

The vehicle should be easy to steer and should not have free play in the steering wheel.

Accelerator Pedal:

As the accelerator pedal is pushed, the vehicle should come smoothly up to full speed. When the pedal is released, it should return to the original position and the engine or motor should stop gradually. The Carryall-I Electric and Tourall Electric operate at half speed in reverse.

Governor:

Check the speed of the vehicle. The Carryall-I and Tourall Gas and Electric should run 12-14 MPH on a level surface. The Carryall-II should run 14-16 MPH on a level surface. The Carryall-II Plus should run 17-18 MPH on a level surface.

General:

Listen for any unusual noises such as squeaks or rattles. Check the vehicle's ride and performance. Have a CLUB CAR Carryall Dealer or a trained mechanic investigate anything unusual.

WARNING:

Any modification or change to the vehicle which affects the stability or increases the speed beyond the factory specifications could result in severe personal injury or death.

Controls — All Vehicles:**WARNING:**

If renting or loaning this vehicle, make sure that the driver is familiar with all controls and operating instructions before allowing the vehicle to be driven.

Key Switch - The key switch is mounted on the dash to the right of the steering column (See Figure 2). It has two (2) positions, "On" and "Off" which are clearly labeled. Remove key in the "Off" position only.

WARNING:

Turn key switch to "Off" and remove key when leaving vehicle to avoid unintentional starting of the vehicle.

Forward-Reverse Control - The forward-reverse shift lever is located below and to the right of the driver's knee on the seat support panel (See Figure 3). The lever has three (3) distinct positions: F (forward), N (neutral), and R (reverse). Rotate the lever toward the driver (F) to run vehicle in forward and toward the passenger (R) to run vehicle in reverse. When the lever is in the straight up or neutral position, the vehicle will not run, and the engine will stop if shifted to this position while running. The Carryall-I Electric and Tourall Electric operate at half speed in reverse.

WARNING:

Do not shift forward and reverse lever while vehicle is in motion. Always bring vehicle to a full stop before shifting lever to avoid injury to an unsuspecting passenger or damage to the vehicle.

Turn key switch "Off" and place shift lever in neutral when leaving vehicle to avoid unintentional starting of the vehicle.

Buzzer will sound as a warning when vehicle is in reverse.

Accelerator Pedal - The accelerator pedal is the pedal on the right with the word "GO" molded in it (See Figure 4). When the key switch is "On," and the shift lever is in either forward or reverse, and the accelerator pedal is pushed, the parking brake will be automatically released and the engine will start. As the pedal is pushed further, the engine speeds up, and the vehicle will begin to move in the preselected direction (forward or reverse). Push the accelerator pedal still further to increase vehicle speed. When the accelerator pedal is released, power to the motor will be cut off or the engine will stop running.

The accelerator pedal differs from that of an automobile in the following way: Depressing the accelerator will release the parking brake if engaged. Depressing the accelerator automatically starts the vehicle moving. Each time the accelerator pedal is released, the engine/motor will stop running.

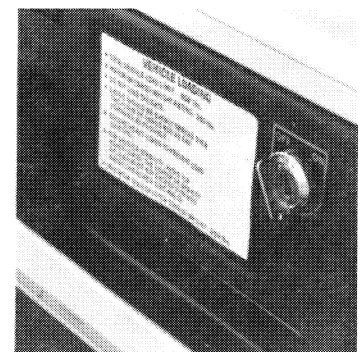

Figure 2

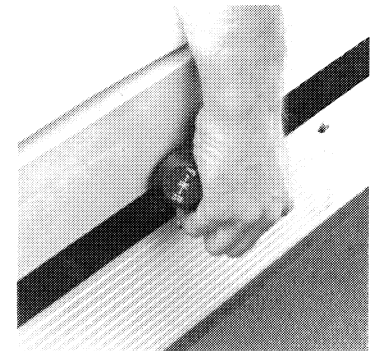

Figure 3

WARNING:

Do not tamper with the gasoline vehicle's governor. To do so will void the limited warranty, result in damage to engine and other components, and may result in injury due to unsafe speeds.

Brake Pedal - The brake pedal is the large pedal on the left with the word "STOP" molded in (See Figure 5). To slow or stop the vehicle, push the brake pedal with your right foot.

Parking Brake Pedal - The parking or park brake pedal is the small raised portion in the upper left corner of the brake pedal with the word "PARK" molded in (See Figure 5). The words "Park Brake" are marked above this pedal. To set the park brake, push the brake pedal firmly and tilt the park brake portion of the pedal forward with your right foot (See Figure 6).

The parking brake will release when the accelerator or brake pedal is pushed. **The parking brake has multiple locking positions and should be firmly pressed to prevent vehicle from rolling.**

WARNING:

The park brake should be firmly depressed before leaving the vehicle to prevent the vehicle from rolling.

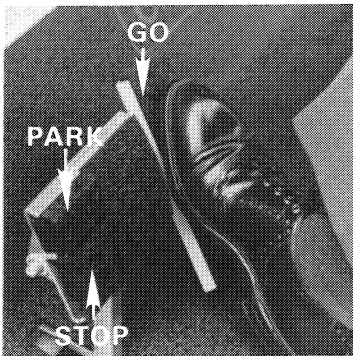

Figure 4



Figure 5

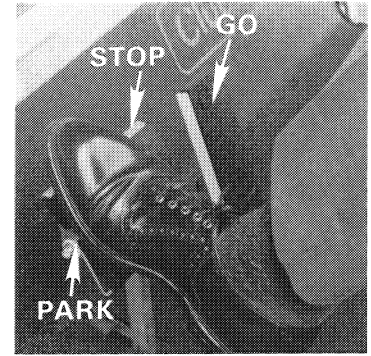

Figure 6

Controls — Carryall-I, Carryall-II and Tourall Gas:

Neutral Lock-Out - The vehicle has a neutral lock-out circuit that prevents the driver from starting the vehicle in neutral. If the vehicle is started in forward or reverse and shifted to neutral, the engine stops running.

DANGER:

Engines produce carbon monoxide which is an odorless, deadly poison. DO NOT OPERATE IN AN ENCLOSED AREA WITHOUT PROPER VENTILATION.

For the convenience of the trained and experienced mechanic, there is a neutral lock-out cam located on the back of the forward and reverse lever. If the neutral lock-out cam is pulled out approximately $\frac{3}{8}$ of an inch and then rotated one-half turn until it snaps into place, the vehicle will be in the SERVICE position (See Figure 7). This will allow the mechanic to run the vehicle in neutral for certain maintenance procedures. With the cam in this position, the vehicle will not run if the forward and reverse lever is placed in the forward or reverse position. To put the vehicle back into the OPERATE position, pull the cam out approximately $\frac{3}{8}$ of an inch and rotate it one-half turn until it snaps into place (See Figure 8).

NOTE: Be sure to return cam to OPERATE position.

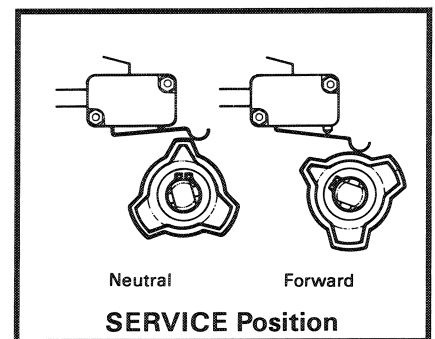

Figure 7

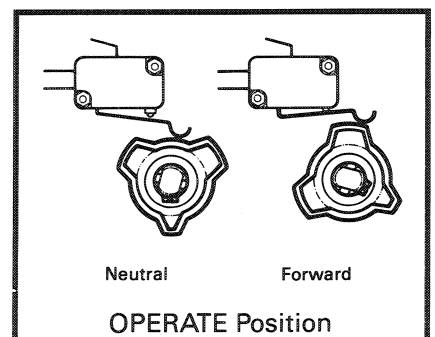

Figure 8

WARNING:

With cam in **SERVICE** position, vehicle may move suddenly if forward and reverse lever is shifted or accidentally bumped while engine is running.

Block front and rear wheels to prevent vehicle movement.

Always firmly set the park brake before leaving the vehicle to prevent the vehicle from rolling.

Choke - The choke is located below and to the left of the driver's left knee on the seat support panel (See Figure 9). If on a cool morning the vehicle is hard to start, simply push in the choke cover with your left hand to activate the choke. Release the choke after the engine starts and runs smoothly.

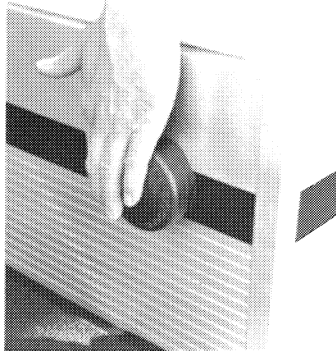

Figure 9



Figure 10

Oil Light - The Carryall and Tourall Gasoline are equipped with a dash mounted oil light above the steering column (See Figure 10). When the oil light is on, it indicates low engine oil. Oil should be added before further use. The vehicle should never be driven if the oil light comes on and stays on. If the oil light goes on and off, you may proceed, but add oil at the first opportunity. If the oil level is correct and light stays on, have a trained and experienced mechanic check the vehicle.

Driving Instructions — All Vehicles:

No one should drive the vehicle without first being instructed in the proper operation and use of the vehicle controls. An experienced operator should accompany each first-time driver on a test drive before they operate the vehicle alone. Only licensed drivers should be allowed to drive this vehicle. Do not drive under the influence of alcohol, drugs or medications.

WARNING:

If renting or loaning this vehicle, make sure the driver is familiar with all controls and operating procedures before allowing the vehicle to be driven.

This vehicle is not specially equipped for handicapped persons. Be sure all persons can properly operate vehicle prior to allowing them to drive vehicle.

To insure safe operation of the Carryall or Tourall, follow all of the procedures listed below exactly and in order. Read and understand all instructions prior to driving the vehicle.

Starting the Vehicle:

1. Be sure load (if any) is secure.
2. Enter the vehicle.
3. Be sure everyone is seated and holding onto seat handles or handrail (See Figure 11).
4. Study and understand controls.
5. Read safety warnings located above pedals.
6. Make sure wheels are turned in desired direction.
7. Be sure nothing is in your path.
8. Turn key to "On" position.
9. Select direction by placing shift lever in desired position F = forward or R = reverse.
10. Slowly push accelerator pedal to increase speed. The park brake pedal will release and the vehicle will move and the speed will increase as the accelerator is depressed until governed speed is reached.

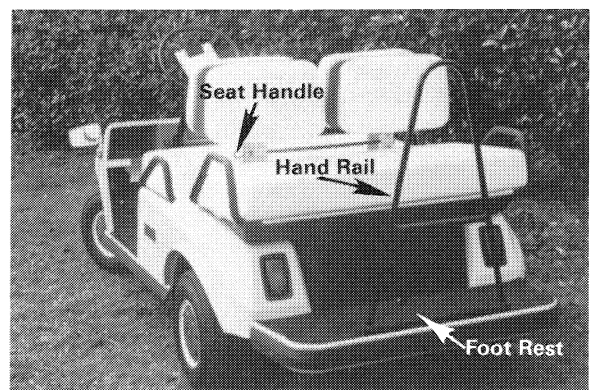

Figure 11

WARNING:

No more than two people should be on the Carryall-I or Carryall-II at one time. Do not allow people in cargo bed.

No more than four people should be on the Tourall at one time.

Do not shift forward and reverse lever while vehicle is in motion. Always bring vehicle to a full stop before shifting lever to avoid injury to an unsuspecting passenger or damage to the vehicle.

A buzzer will sound as a warning when the vehicle is in reverse.

WARNING:**When Driving The Vehicle:**

- Operate the vehicle from the driver's seat only.
 - Remain seated in moving vehicle and hold on to seat handles or handrails at all times to prevent falls.
 - Keep arms, legs, feet and entire body inside vehicle to prevent getting them caught between the vehicle and the ground or other objects.
 - Drive slowly when loaded in turns and drive slowly straight up and down slopes to prevent turning the vehicle over.
 - Avoid stopping on hills when fully loaded since starting, rolling backwards, or sudden stops can cause vehicle to overturn or flip over backwards.
 - Avoid sudden starts, stops, and tight turns to avoid injury to an unsuspecting passenger and damage to vehicle.
 - Reduce speed when backing and for poor driving conditions such as wet grass or rough terrain to avoid losing control of vehicle or turning vehicle over.
 - Do not use on public roads. This vehicle is not designed or intended for street use and should not be licensed for use on public roads.
 - Vehicles should be driven only in specified areas by trained people.
-

Stopping the Vehicle:

1. To stop the vehicle, release the accelerator pedal and push the brake pedal with your right foot.

CAUTION:

When stopped on a hill, use the brakes to hold your position, not the accelerator pedal.

WARNING:

Driving through deep water may affect the brakes. Check their effectiveness by pressing the brake pedal gently. If the vehicle does not slow down at the normal rate, continue to apply the brakes gently until they dry out and normal performance returns.

Parking and Leaving the Vehicle:

1. After stopping the vehicle, firmly push park brake pedal until it locks. This will prevent the vehicle from rolling.
2. Turn key to "Off" and place shift lever in the straight up "Neutral" position when the vehicle is not in use. This avoids unintentional starting of engine. Remove key when vehicle is not in use.

WARNING:

To avoid being struck by vehicle, do not stand in front of or behind vehicle.

Loading and Unloading — Carryall-I and Carryall-II:

WARNING:

Firmly engage park brake prior to loading.

Do not allow people in cargo bed.

Do not exceed 300 lbs. in Carryall-I cargo bed, 800 lbs. in the Carryall-II cargo bed, and 600 lbs. in the Carryall-II Plus cargo bed. Overloading can cause loss of vehicle control and severe personal injury by causing a vehicle component to fail or by affecting vehicle handling.

Vehicle rated capacity should not exceed 800 lbs. for Carryall-I, 1200 lbs. for Carryall-II, and 1000 lbs. for Carryall-II Plus. This includes all passengers, load in cargo bed, and tongue weight of trailer. Tongue weight of any trailer should not exceed 150 lbs. Overloading can cause loss of vehicle control and severe personal injury by causing a vehicle component to fail or by affecting vehicle handling.

Rated capacity is for level surfaces only. When driving up or down hills or on uneven terrain, vehicle speed and load must be reduced.

When backing up, reduce speed and avoid sudden stops which can cause front wheels to lift off the ground and the vehicle to overturn.

If vehicle is equipped with tailgate, do not load tailgate. Tailgate should be in upright position and latched securely while vehicle is in motion.

When vehicle is loaded, make starts, stops and turns in a smooth manner to avoid shifting the load or overturning the vehicle or both. The cargo center of gravity may affect the handling, steering, and braking of the vehicle.

Loose cargo should be secured to keep it from being thrown about, which could affect handling and injure the driver or passenger if vehicle is suddenly stopped.

Avoid top heavy loads. The center of gravity of load should never exceed 15 inches above cargo bed bottom.

-
1. Center cargo in cargo bed as far forward as possible and secure.

Towing — Carryall-I and Carryall-II:

When towing a trailer with the Carryall, extra caution should be observed due to the trailer's adverse effects on the handling of the vehicle. Gross trailer weight should not exceed 800 lbs. for the Carryall-I, 1200 lbs. for the Carryall-II, or 1000 lbs. for the Carryall-II Plus. The tongue weight should not exceed 150 lbs. Parking the vehicle with a trailer on a hill should be avoided. If you must park on a hill, apply the brakes and have someone block the tires of the trailer. Brakes should be released to allow the blocks to absorb the load of the trailer. After wheels have been blocked, engage park brake.

WARNING:

Never operate vehicle on public streets or highways.

Extreme caution should be used when towing a trailer.

Do not exceed gross trailer weight of 800 lbs. for the Carryall-I, 1200 lbs. for the Carryall-II, or 1000 lbs. for the Carryall-II Plus.

Do not exceed tongue weight of 150 lbs. for all Carryall vehicles.

Do not allow people in trailer being towed.

Avoid stopping on hills when fully loaded since starting, rolling backwards, or sudden stops can cause vehicle to overturn or flip over backwards.

Avoid sudden starts, stops and tight turns.

Slower speeds should be observed when towing a trailer.

Transporting on a Trailer:

If your Carryall must be transported over long distances or on public highways, it should be done on an approved trailer observing all the following warnings and precautions.

WARNING:

For use on public roads the trailer must meet all federal, state and local requirements such as taillights, brake lights, etc.

Always use an approved trailer that has a load rating of 1200 lbs. per vehicle. (Example: A 2-vehicle trailer should be rated at $2 \times 1200 = 2400$ lbs.).

The vehicle should be securely tied down to the trailer. The vehicle's key switch should be "Off", the shift lever in "neutral" and the park brake firmly applied and locked.

When towing a trailer, normal speeds should be reduced and care should be used when turning a corner due to the added length of the trailer.

Never tow a Carryall behind a passenger vehicle or truck unless it is on an approved trailer.

Never transport a Carryall on a trailer with a load in the cargo bed.

Storage — Carryall-I, Carryall-II and Tourall Gas:

To prepare your vehicle for extended off season storage:

WARNING:

Turn key switch "Off", remove key and place forward and reverse lever in neutral position to avoid unintentional starting of the vehicle.

1. Store in a cool place. This will prevent self discharge of the battery. If the battery appears to be weak, have it charged by a trained mechanic.

CAUTION:

Batteries in a low state of charge will freeze at low temperatures.

WARNING:

Do not attempt to charge a battery if it is frozen or the case is bulged. Discard battery. Frozen batteries can explode.

2. Using a siphon with a suction device (See Figure 12), drain all of the gasoline out of the tank into an approved gasoline container.

WARNING:

Never attempt to siphon gasoline using a hose without a built-in suction device.

Never attempt to siphon gasoline using your mouth.

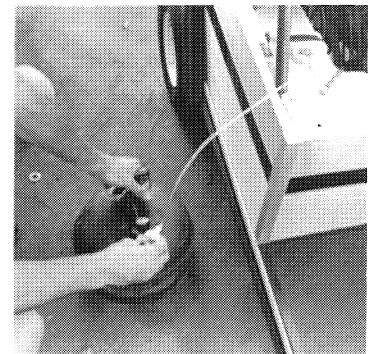

Figure 12

DANGER:

Gasoline — Flammable — Explosive — Do Not Smoke. Keep sparks and flames away from area of vehicle.

Do not attempt to drain gasoline while engine is running or hot.

Store gasoline only in an approved gasoline container in a well-ventilated area. Keep out of reach of children. Keep sparks and flames away from area of gasoline.

Engines produce carbon monoxide which is an odorless, deadly poison. **DO NOT OPERATE IN AN ENCLOSED AREA WITHOUT PROPER VENTILATION.**

-
3. Be sure the tank has been drained and the stored gasoline has been removed from the area. Place the forward and reverse lever in "Neutral". Place neutral lock-out cam in the SERVICE position. Run the engine until all of the gasoline has been drawn out of the fuel lines and carburetor and engine stalls. Return neutral lock-out cam to the OPERATE position. Turn the key to the "Off" position and remove key.
 4. To protect the engine, remove the spark plug and pour 1/2 ounce of SAE 10 weight oil into the engine through the spark plug hole. Rotate the engine several times and then re-install the spark plug.
NOTE: When restarting engine, it may smoke excessively due to oil added in Step 4.
 5. Increase the tire pressure to 20 psi.
 6. Grease front suspension and do all quarterly periodic lubrication shown in lubrication chart on Pages 22 and 23.
 7. Thoroughly clean cowl, cargo bed, seats, engine compartment and underside of vehicle.
 8. Do not latch the park brake. Block the wheels to prevent the vehicle from rolling.

To Return Stored Vehicle to Service:

1. Fill the gas tank with regular or unleaded gasoline (See Fueling Instructions - Page 24).

DANGER:

Gasoline — Flammable — Explosive — No Smoking. Keep sparks and flames from the area of the vehicle. Only service or repair in well-ventilated area. Never pour gasoline into tank while engine is hot or running. Do not overfill. Be sure to clean up any spilled gas before operating vehicle.

2. Readjust tire pressure to 12-14 psi, 18 psi for heavy loads.
3. Perform the pre-operation checks before returning the vehicle to service (See Page 12).

Storage — Carryall-I and Tourall Electric:

To prepare your vehicle for extended off season storage:

WARNING:

Turn key switch "Off", remove key and place forward and reverse lever in neutral position to avoid unintentional starting of the vehicle.

1. Fully charge batteries.

CAUTION:

Batteries in a low state of charge will freeze at low temperatures.

When washing vehicle, do not direct water stream at speed switch.

WARNING:

Do not attempt to charge a battery if it is frozen or the case is bulged. Discard battery. Frozen batteries can explode.

2. Wash off any corrosion around the terminals with a solution of baking soda and water. Rinse. (NOTE: Do not allow this solution to enter the battery.) Let the terminals dry and coat them with grease or protective spray.
3. Store in cool, dry place. This will prevent self discharge of the batteries.
4. Recharge batteries every 6-8 weeks, as necessary (See Page 28).
5. Increase the tire pressure to 20 psi.
6. Grease front suspension and do all quarterly periodic lubrication shown in lubrication chart (See Pages 22 and 23).
7. Thoroughly clean body, seats and underside of vehicle.
8. Do not latch the park brake. Block the wheels to prevent the vehicle from rolling.

To Return Stored Vehicle To Service:

1. Fully charge batteries (See Page 28).
 2. Readjust tire pressure to 18 psi.
 3. Perform the pre-operation checks (See Page 12) before returning the vehicle to service.
-

Maintenance:

General Information - To be sure you have a trouble-free vehicle, it is very important to follow an established preventive maintenance program. This is the least expensive maintenance requirement. Preventive maintenance means regularly scheduled services which include certain maintenance procedures that are performed on the vehicle even though the vehicle is functional. A good preventive maintenance program can prevent more expensive repairs from being required. Any vehicle that is not functioning correctly should be removed from use until it is properly repaired.

Contact your local CLUB CAR Carryall Dealer to perform all repairs and the semi-annual and annual periodic service.

NOTE: If vehicle is constantly hauling heavy loads or hauling a trailer, these preventive maintenance procedures should be performed more often than recommended in the periodic service schedule.

Bed Latch

1. Both the Carryall-I and Carryall-II are equipped with a bed latch on the driver's side of vehicle as standard equipment (See Figure 13).
2. To lift bed, push latch handle toward rear of vehicle, and lift bed (See Figure 14).

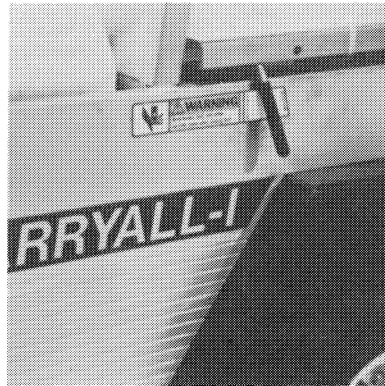

Figure 13

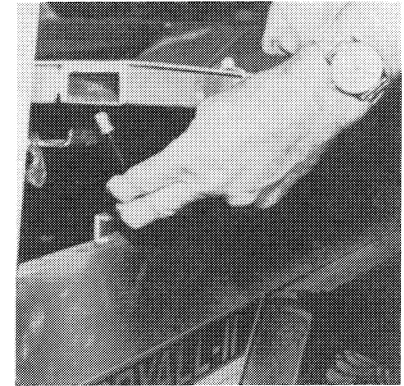

Figure 14

WARNING:

Keep hands and fingers clear of pinch point between bed and seat back support.

3. To close bed, lower bed gently (do not drop) until bed latch engages.
4. The Carryall-II is equipped with an automatically engaging bed prop rod (See Figure 15).

WARNING:

Only trained people should repair or service this vehicle. Everyone doing even simple repairs or service should follow the correct procedures and obey the warnings listed in this manual as well as the maintenance and service manual.

Turn key switch "Off", remove key, and place forward and reverse lever in neutral position prior to servicing.

Always wear safety glasses or eye protection when servicing this vehicle.

Moving Parts — Do not attempt to service the vehicle with engine running.

Hot — Do not attempt to service hot engine, motor, resistors or exhaust system. Can cause extreme burns.

Remove spark plug wire on gas vehicle to avoid unintentional starting of engine when servicing vehicle.

Disconnect batteries on electric vehicle before servicing vehicle (See Inside Front Cover).

When lifting bed and vehicle is equipped with a tailgate ramp, be sure persons are clear of rear of vehicle.

If vehicle has a portable refreshment center option installed in the bed, it must be removed before unlatching bed latch and lifting bed.

Do not remove prop rod or close bed until all persons are clear of bed area. Do not drop cargo bed; lower gently and keep head, fingers, feet and arms clear. Failure to follow these instructions can cause severe personal injury.

Do not work on the powertrain or under tilt bed while the bed or box is loaded.

If vehicle is equipped with hydraulic tilt bed option, remove bed before servicing hydraulic system.

Hydraulic system is under pressure and a face shield should be worn when servicing. Extreme care should be exercised when servicing the hydraulic system.

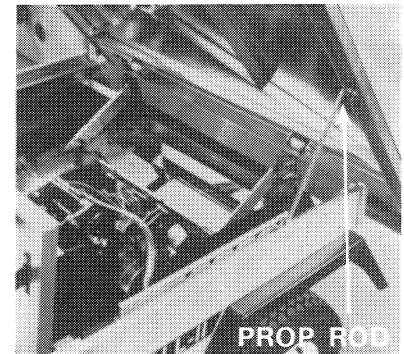

Figure 15

Periodic Lubrication Schedule and Lubrication Chart — Carryall-I, Carryall-II and Tourall Gas:

Regular Interval	Service	Recommended Lubricant
Quarterly by Owner or Trained Personnel	<ol style="list-style-type: none"> 1. Brake shaft bearing and hinges 2. Brake linkage and pivots 3. Accelerator push rod pivots and shifter cable pivots 4. Front suspension (5 fittings) 	Dry Moly Lube CLUB CAR part #1012151 Dry Moly Lube CLUB CAR part #1012151 Dry Moly Lube CLUB CAR part #1012151 Chassis Lube
Annually by Trained Personnel Only	<ol style="list-style-type: none"> 5. Check/fill drive unit to plug level 6. Check/fill transmission to plug level 7. Inspect front wheel bearings Repack as necessary 	22 oz. SAE 30 WT. API Class SF, SE or SD Oil 80-90 WT. API Class GL-3 or 80-90 WT. AGMA Class 5 EP Gear Lube Chassis Lube
Every 2 Years or 300 Hours of Operation by Trained Personnel Only	<ol style="list-style-type: none"> 8. Change engine oil and oil filter 	44 oz. (with filter) SAE 30 above 32°F (0°C) or SAE 5W20 below 32°F (0°C) Classification SF, SE or SD

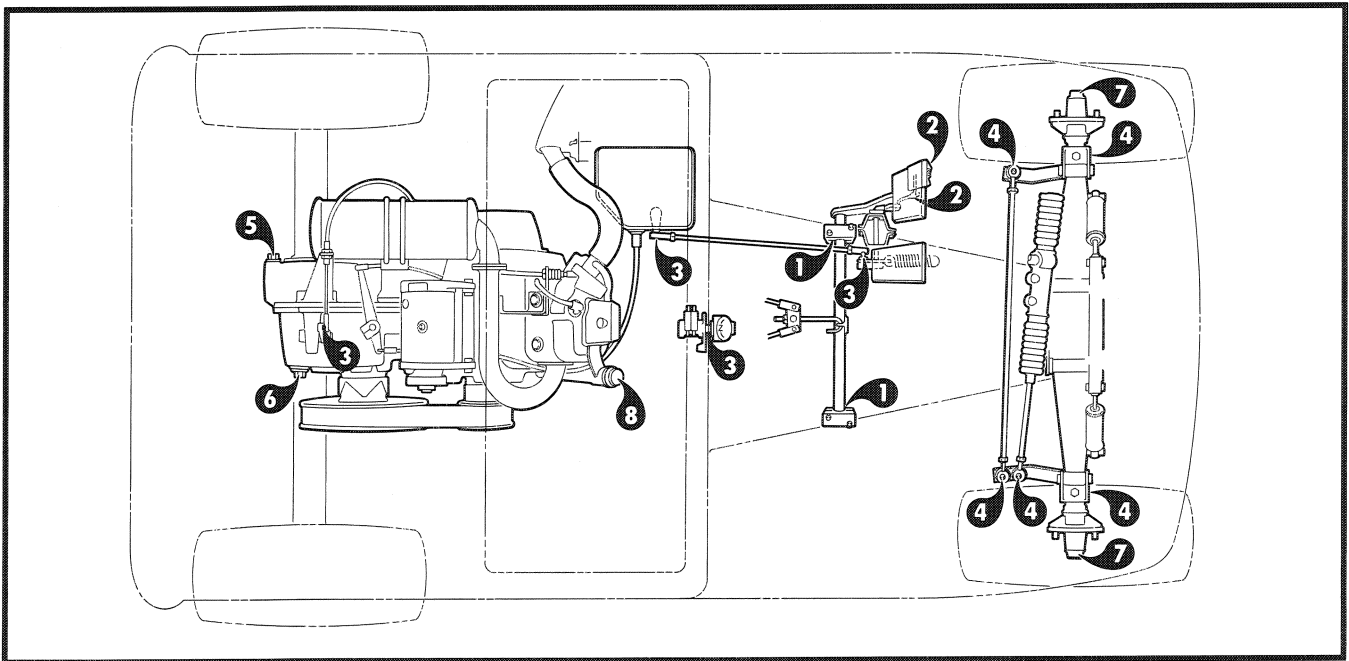

Figure 16

Engine Oil:

Engine oil level should be checked at least monthly. The oil light on the dash should warn you if your oil is getting low (See Figure 17).

CAUTION:

Engine must be in level position. Remove oil level dipstick by pulling from crankcase and clean. Check oil by inserting the dipstick with the letters up and fully seating gauge into oil filler hole. If oil does not reach the upper line (mark) of the gauge, add oil until it does. Do not overfill with oil. When oil is at proper level, reinsert dipstick.

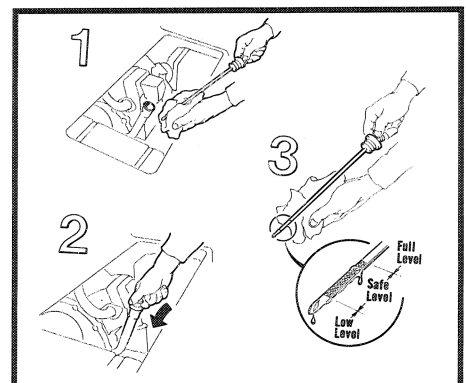

Figure 17

Periodic Lubrication Schedule and Lubrication Chart — Carryall-I and Tourall Electric:

Regular Interval	Service	Recommended Lubricant
Quarterly by Owner or Trained Personnel	1. Brake shaft bearing	Dry Moly Lube CLUB CAR part #1012151
	2. Brake linkage and pivots	Dry Moly Lube CLUB CAR part #1012151
	3. Accelerator push rod pivots	Dry Moly Lube CLUB CAR part #1012151
	4. Front suspension (5 fittings)	Chassis Lube
Annually by Trained Personnel Only	5. Check/fill drive unit to the level plug	22 oz. SAE 30 WT. API Class SF, SE or SD Oil
	6. Inspect front wheel bearings and repack as necessary	Chassis Lube

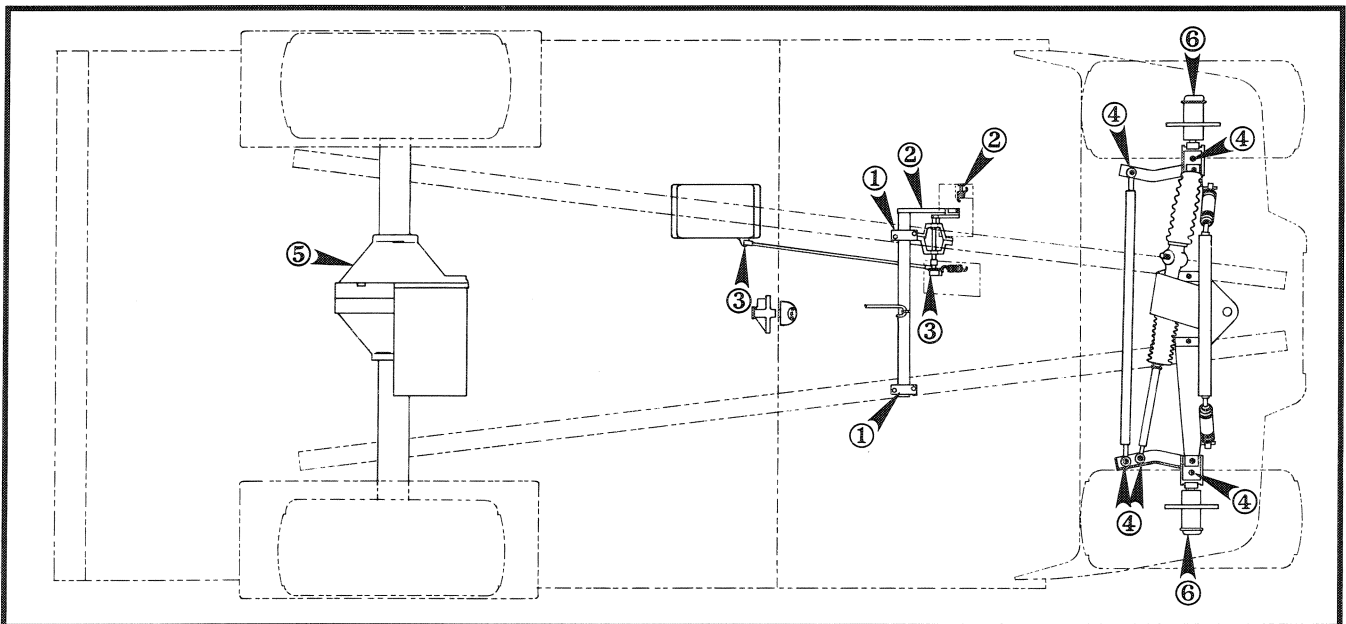

Figure 18

Capacities:

	Carryall-I, Tourall and Carryall-II Gas	Carryall-I and Tourall Electric	Carryall-II Plus
Engine Crankcase without filter	38 oz.		37 oz.
Engine Crankcase with filter	44 oz.		44 oz.
Transmission	20 oz.		20 oz.
Drive Unit	22 oz.	22 oz.	22 oz.
Gasoline Tank	7.0 U.S. Gal.		7.0 U.S. Gal.
Tire Pressure	12-14 psi (Heavy Loads — 18 psi)	18 psi (Heavy Loads — 20 psi)	50 psi

Fueling Instructions — Carryall-I, Carryall-II and Tourall Gas:

DANGER:

GASOLINE - FLAMMABLE - EXPLOSIVE - NO SMOKING

Keep sparks and flames from the area of the car. Only service or repair in well-ventilated area. Never pour gasoline into tank while engine is hot or running.

To avoid electric arc caused by static electricity, the fuel storage/pumping device must be grounded. If pump is not grounded, the vehicle must be grounded to the pump before and during the fueling operation.

If vehicle has a Custom Cab Assembly or an all weather enclosure installed, the gas tank must be properly vented to the rear of the vehicle as shown in Figure 19.

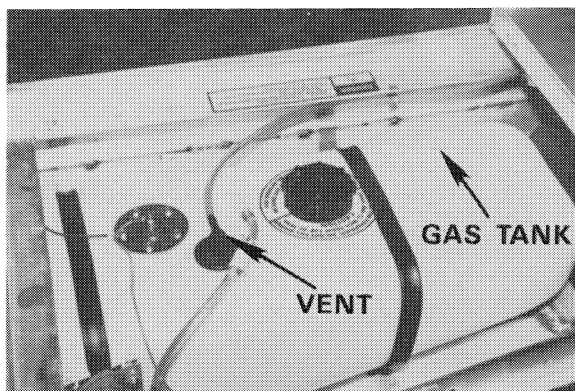

Figure 19

1. Remove seat bottom.
2. Fuel tank is located on passenger side of vehicle. Remove fuel cap and fill the fuel tank with regular or unleaded gasoline. Do not use gasohol or gasolines with methyl alcohol blends.

CAUTION:

To allow for expansion, do not fill higher than one (1) inch from top of tank.

DANGER:

Be sure to clean up any spilled gas before operating vehicle.

3. Replace fuel cap on tank, being sure cap is tightly sealed to tank.
4. Replace seat bottom.

Battery — Carryall-I, Carryall-II and Tourall Gas:

WARNING:

Always wear safety glasses or eye protection when servicing the vehicle.

Always use insulated tools when working around batteries or electrical connections.

DANGER:

Battery - Explosive Gases. Keep sparks, flames, and cigarettes away. Ventilate when charging in an enclosed space.

Poison - Contains acid - Causes severe burns - Avoid contact with skin, eyes or clothing.

Antidotes:

External - Flush with water. Call physician immediately.

Internal - Drink large quantities of milk or water, follow with milk of magnesia or vegetable oil. Call physician immediately.

Eyes - Flush with water for 15 minutes. Call physician immediately.

The battery in the Carryall Gasoline is a 12 volt, maintenance free battery that does not require periodic watering of the battery (See Figure 20).

Any corrosion around the positive (+) or negative (-) terminals should be washed off with a solution of baking soda and water. Rinse. Be sure terminals are tight. Let the terminals dry and then spray them with CLUB CAR battery protector spray, part #1014305.

Be sure battery holddowns are properly tightened. Torque to 9-14 in.-lbs. A loose holddown may allow the battery to become damaged from vibration or jarring. A holddown that is too tight may buckle or crack the battery case.

If battery appears weak, have it charged by a trained mechanic.

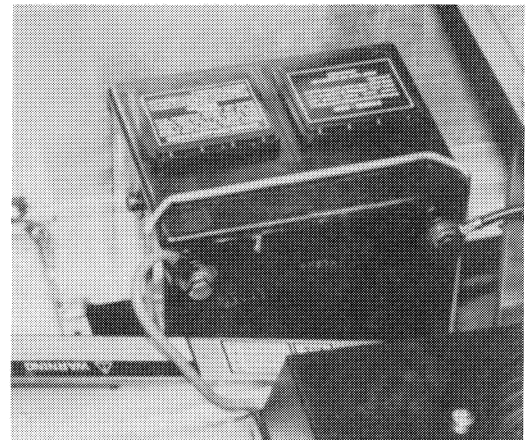

Figure 20

Jump Starting The Engine — Carryall-I, Carryall-II and Tourall Gas:

To start a vehicle with a dead battery, use another battery of the same voltage, and proper jumper cables.

WARNING:

Always wear safety glasses or eye protection when servicing the vehicle.

Procedures other than those which follow could cause severe injury or death from battery acid spray, explosion, or charging system overload.

Never connect to the negative (-) terminal of the "Dead" battery, connect to the frame (See Figure 21).

Never allow the two vehicles to touch each other.

Never allow the jumper cable clamps to touch each other.

Never lean over the battery when making connections.

Place forward and reverse lever in neutral position, and place neutral lock-out cam in SERVICE position.

To connect the jumper cables, follow these steps exactly and in order (See Figure 22):



Figure 21

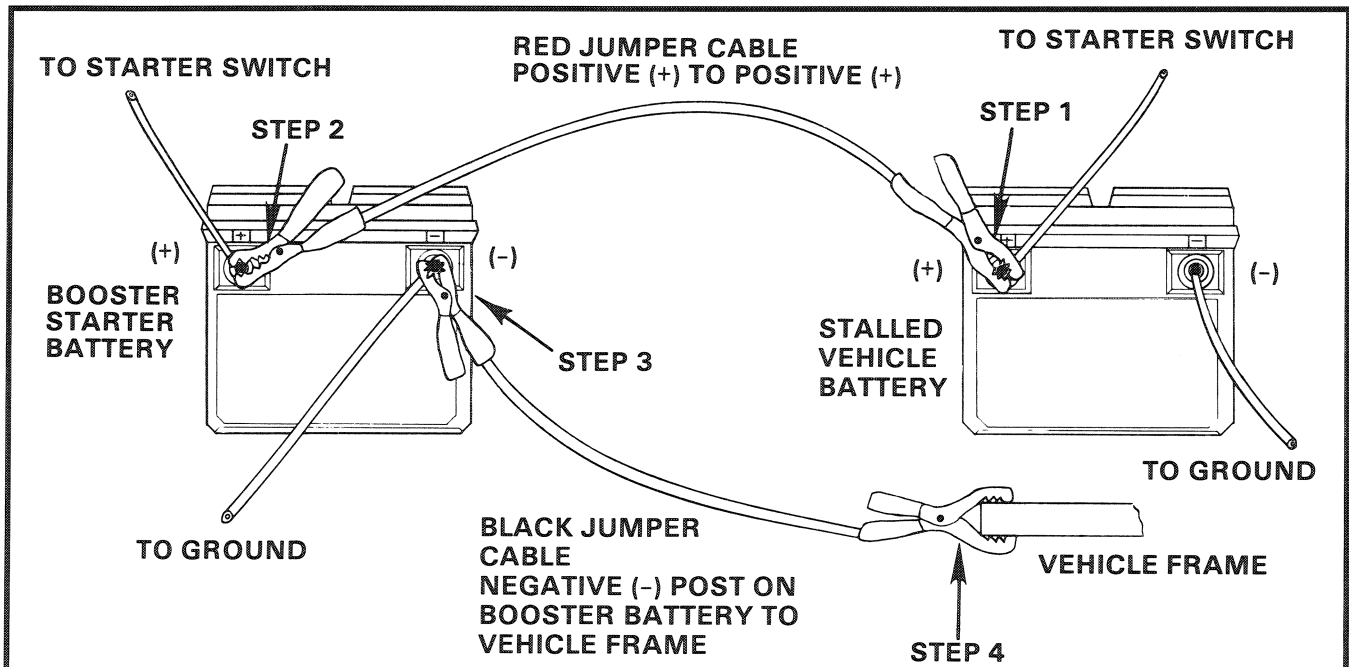

Figure 22

1. Connect one end of red jumper cable to positive (+) terminal of the stalled vehicle battery.
2. Connect other end of red jumper cable to positive (+) terminal of booster battery.
3. Connect one end of black jumper cable to negative (-) terminal of booster battery.
4. Connect other end of black jumper cable to stalled vehicle frame away from gasoline and battery as in Figure 21.

To remove the cables, reverse the above procedures exactly.

Batteries — Carryall-I and Tourall Electric:

General

Power is supplied by six batteries of 6 volts each. These batteries are deep cycle batteries, especially built for an electric vehicle application. Automotive batteries should never be used. New batteries will not deliver their full range until they have been run and recharged from 20 to 50 times. Restrict vehicle with new batteries to one (1) hour of use between charges in the first two months.

WARNING:

Always wear safety glasses or eye protection when servicing the vehicle.

Always use insulated tools when working around batteries or electrical connections.

DANGER:

EXPLOSIVE GASES - Batteries emit hydrogen while being charged. Hydrogen is an **EXPLOSIVE GAS**. Keep sparks, flames, cigarettes away. Tools, wires and metal objects can cause sparks when "shorted" across a battery or batteries. Do not use without proper instructions.

POISON - CONTAINS ACID - Causes severe burns - Avoid contact with skin, eyes or clothing.

Antidotes:

External - Flush with water. Call physician immediately.

Internal - Drink large quantities of milk or water, follow with milk of magnesia or vegetable oil. Call physician immediately.

Eyes - Flush with water for 15 minutes. Call physician immediately.

Battery Care:

To keep your batteries in good condition, follow this maintenance program on a regular basis:

1. The batteries should be kept clean and free of corrosion. Wash tops and terminals of batteries with a solution of baking soda and water. (NOTE: Do not allow this solution to enter the battery.) Rinse. Be sure terminals are tight. Let the terminals dry and then spray them with CLUB CAR battery protector spray, part #1014305.
2. The water level in the batteries should be checked weekly (See Figure 23 for proper level). Add water only after charging unless the water level is below the top of the plates. In this case, add just enough water to cover the plates, charge and then check the level again. For best battery life, add only distilled water to the batteries.

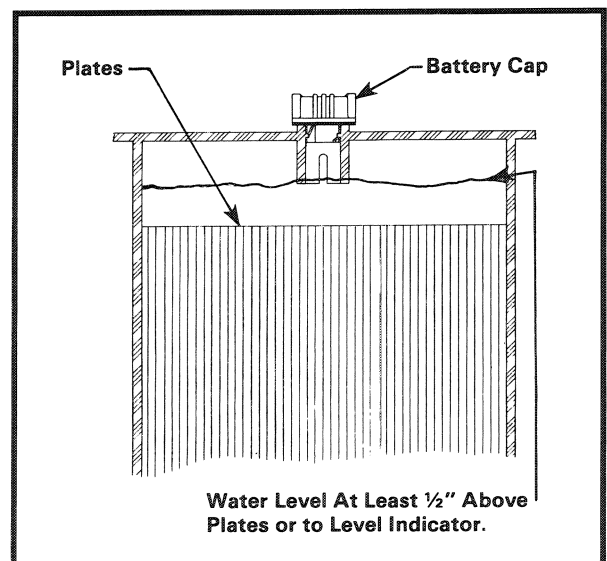

Figure 23

-
3. The hold down bars should be tight enough so the batteries do not move while the vehicle is in motion, but not so tight as to crack or buckle the battery case. Torque to 9-14 in.-lbs. The terminal connections should be clean and tight, and any worn or frayed wires should be replaced.
 4. After use, the batteries should be placed on charge. The batteries should never be left discharged for any length of time.

Battery Charger — Carryall-I and Tourall Electric:

General

Each Carryall-I and Tourall Electric is supplied with a fully automatic battery charger as standard equipment. The AC line to which the charger is to be connected must be capable of supplying 10 amperes to each charger.

WARNING:

Each charger should have its own 20 ampere (maximum) branch circuit protection (circuit breaker or fuse), in accordance with the National Electrical Code, ANSI/NFPA 70, and local codes and ordinances.

This battery charger must be grounded to reduce the risk of electric shock. This charger is equipped with an AC electric cord having an equipment-grounding conductor and a grounding type plug and is for use on a nominal 115 Volt, 60 Hertz circuit. This plug must be connected to an appropriate receptacle that is properly installed and grounded in accordance with the National Electrical Code, ANSI/NFPA 70, and all local codes and ordinances.

WARNING:

Improper connection of the equipment-grounding conductor can result in a risk of an electric shock.

Do not use an adaptor to plug this charger into a two-prong outlet. Extension cord or electrical outlet must have a three-prong outlet.

The use of an extension cord with the charger should be avoided. If an extension cord must be used, use a three conductor No. 12 AWG heavy duty cord with ground in good electrical condition and keep it as short as possible (no more than twelve (12) feet). Locate all cords so that they will not be stepped on, tripped over, or otherwise subject to damage or stress.

WARNING:

The use of an improper extension cord could result in a fire or an electric shock. Do not operate this charger if it has received a sharp blow, was dropped or otherwise damaged in any way; contact your nearest CLUB CAR Carryall Dealer. Only trained people should repair or service this charger.

Replace worn, cut or damaged power cords or wires immediately.

Do not disconnect the DC output plug from the battery receptacle when the charger is on. The resulting arcing between the plug and receptacle could cause an explosion. If the charger must be stopped, disconnect the AC supply plug from the wall outlet before disconnecting the charger DC output plug.

Provide adequate ventilation for the charger. Keep all charger ventilation openings at least two (2) inches away from walls and other objects.

CAUTION:

Do not allow clothing, blankets or other materials to cover the charger.

WARNING:

Chargers can ignite flammable materials and vapors. Do not use near fuels, grain dust, solvents, thinners or other flammables.

Keep dry - do not expose to rain.

Charging Guidelines

DANGER:

Batteries emit hydrogen while being charged. Hydrogen is an **EXPLOSIVE GAS**. Charging areas must be ventilated so the **TOTAL** volume of air in the building is changed five (5) times per hour. Exhaust fans should be located at the highest point of the roof.

If vehicle is equipped with a custom cab assembly with doors, one or both doors on cab should be propped open while being charged, to avoid accumulation of hydrogen gas in cab.

If vehicle is equipped with a weatherproof enclosure, it should be unzipped and pulled back while being charged, to avoid accumulation of hydrogen gas in cab.

CAUTION:

Do not leave DC plug plugged in while unattended for more than two consecutive days.

Ventilating fans should be located at the highest point in the room and must be capable of changing the total volume of air in the room five times per hour. Consult a local HVAC engineer.

To charge batteries, insert DC plug into receptacle and the charger will turn on two to five seconds later (See Figure 24). As long as the charger is allowed to shut off by itself, the batteries will be fully charged and overcharging or undercharging should be prevented. Batteries should be put on charge even if only used for 10 minutes. If charger does not seem to be operating properly or the batteries seem weak, contact your nearest CLUB CAR Carryall Dealer.

NOTE: When night air temperatures fall below 65°F, batteries charged in unheated areas should be placed on charge as soon after use as possible. Batteries are warmest immediately after use and cold batteries require more time to fully charge.

Plug and Receptacle

If the charger plug becomes difficult to insert or remove, the receptacle contacts should be lightly sprayed with WD-40 brand spray lubricant. Then the plug should be inserted and removed several times to ensure ease of insertion and removal and good firm electrical contact.

WARNING:

Be sure all wire connections at the receptacle and fuse link are clean and tight.

To connect the charger plug to the vehicle receptacle, grasp the plug handle and push the plug straight into the receptacle. Do not rock or bend the plug (See Figure 24).

To disconnect the charger plug from the vehicle receptacle, grasp the plug by the handle and pull the plug straight out of the receptacle. Do not pull on the cord (See Figure 25). Do not twist, rock or bend the plug.

Failure to follow these instructions could result in damage to the charger cord, plug or vehicle receptacle. Do not use this charger if:

- The plug is too loose or does not make a good connection.
- The plug and receptacle feel hotter than normal during charge.
- The plug blades or contacts are bent or corroded.
- The plug, receptacle or cords are cut, worn or have any exposed wires.
- The plug, cords, charger or receptacle are damaged in any way.

Using this charger with any of the above symptoms could result in a fire, property damage or personal injury.

The DC charger cord and plug are wear items and **must** be replaced when worn or damaged.

If warning tag has been removed from DC cord, have it replaced.

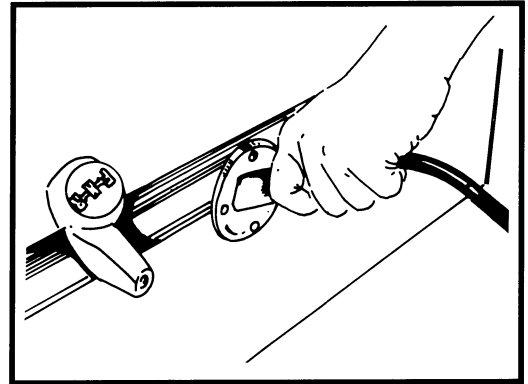

Figure 24

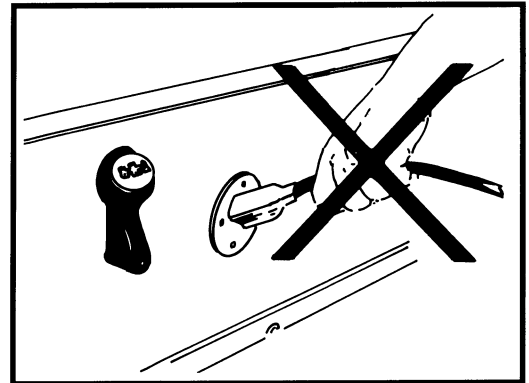

Figure 25

Fuse Link

As an additional feature to help protect the batteries and charging circuit from an overload, the CLUB CAR Carryall-I and Tourall Electric are equipped with a fuse link (See Figure 26). If the charger does not come on when the vehicle is placed on charge, visually inspect the fuse link.

WARNING:

If fuse link is blown, contact your nearest CLUB CAR Carryall Dealer to determine source of the electrical problem and correct it before replacing fuse.

NOTE: On the optional Ultra-Power II, the red charge-on indicator should light when the vehicle is placed on charge.

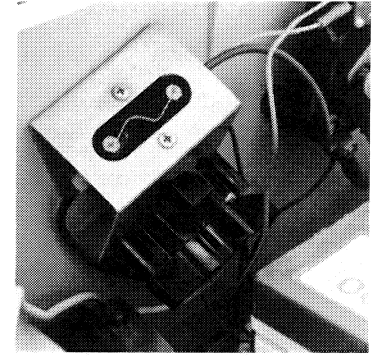

Figure 26

Storage Compartment — Tourall:

There is an enclosed storage compartment underneath the rear seat with two (2) cu. ft. of storage area. The rear seat can be lifted and fastened in place with the elastic cord to give access to the storage compartment (Figure 27).

Optional On-Board Charger — Tourall:

An optional on-board charger is available for the Tourall Electric; it should be plugged into a properly grounded nominal 115 Volt, 60 Hertz outlet. The AC line to which the charger is connected must be capable of supplying 10 amperes to each charger. The rear seat should be held up with the rubber cord while charging (Figure 27).

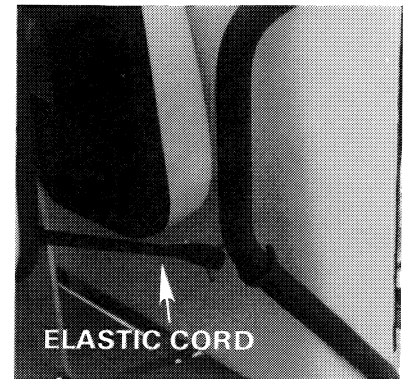

Figure 27

WARNING:

Each charger should have its own 20 ampere (maximum) branch circuit protection (circuit breaker or fuse), in accordance with the National Electrical Code, ANSI/NFPA 70, and local codes and ordinances.

Solid State Controller Vehicle — Carryall-I and Tourall Electric:

If the Carryall-I or Tourall Electric vehicle is equipped with a Solid State Speed Controller, it should be driven and maintained as stated in the Owner's Manual with the following exception:

**ALL REFERENCES TO RESISTOR COILS SHOULD BE DELETED, I.E.,
HOT RESISTOR WARNING DECAL, PERIODIC SERVICE OF
RESISTOR ASSEMBLY, ETC.**

In order to properly service and maintain this Solid State Controller Vehicle, it is necessary to understand the electrical circuitry and the functions of all components in this system. Therefore, if any repairs or service need to be performed, we recommend that they be performed by an authorized CLUB CAR Carryall Dealer using only original CLUB CAR parts.

Cleaning:

Both the Carryall-I and Carryall-II are equipped with a reaction injection molded polymer cowl and an all aluminum cargo bed and body. The Tourall is equipped with a reaction injection molded plastic cowl and a compression molded fiber reinforced plastic body. Use only mild dishwashing liquid soap with a sponge or soft cloth for normal cleaning.

Minor scratches or blemishes in the body can be buffed out using most commercially available polishing compounds and polishes.

Your Carryall and Tourall seats will last longer with proper cleaning. Mild soap or detergent with a sponge or soft cloth for normal cleaning is recommended. For stubborn or imbedded dirt, a soft bristle brush may be used.

Do not use any harsh detergents or cleaning solvents on the body, cowl or seat.

Battery acid, fertilizers, tars, asphalt, creosote, paint or chewing gum should be removed immediately to prevent possible stains.

Accessories and Options:

The Carryall and Tourall are available with a complete line of optional equipment items and accessories. These include a custom cab assembly, driving range protective enclosure, light, horn, taillight packages, all weather enclosures, etc.

Care should be taken that these accessories and options are properly installed by trained people and that the accessories are used only for the purpose for which they were designed.

WARNING:

Custom cab assemblies, all weather enclosures, vinyl door kits, solid door kits or tinted windshields will not protect occupants from flying objects. The driving range protective enclosure is the only enclosure designed to protect the occupants from golf balls.

Subsequent Owner Registration:

In the event that this vehicle has been bought as a used vehicle from another individual or from a distributor/dealer, re-registration is necessary. This will enable us to contact you if the need arises. Please send your name, address and serial number(s) of the vehicle(s) to CLUB CAR, INC., P.O. Box 204658, Augusta, GA 30917-4658, ATTN: Vehicle Registration.

SPECIFICATIONS	CARRYALL-I GAS	CARRYALL-I ELECTRIC	CARRYALL-II GAS	CARRYALL-II PLUS	TOURALL GAS	TOURALL ELECTRIC
Power Source						
Engine...4-cycle, OHV, 290 cc, 9.0 hp, single cylinder, air cooled pressure lubrication system	•	—	•	•	•	—
Drive Motor...Direct Drive, 36 volt DC, Series Wound, 2.97 hp	—	•	—	—	—	•
Carburetor...Float bowl with fixed jets and impulse fuel pump	•	—	•	•	•	—
Governor...Automatic ground speed sensing, internally geared in transmission	•	—	•	•	•	—
Ignition...Transistor electronic ignition with electric RPM limiter	•	—	•	•	•	—
Transmission...Fully synchronized forward and reverse with 0.97:1 ratio forward, 1.03:1 ratio reverse and neutral	•	—	•	—	•	—
Transmission...Fully synchronized forward 0.97:1 ratio	—	—	—	•	—	—
Drive Unit...Double reduction helical gear with 12.28:1 direct drive axle	•	•	•	•	•	•
Electrical System...36 volt DC, 18 volt reverse	—	•	—	—	—	•
Electrical System...12 volt 325 cold cranking amp battery and 35 amp charging capacity	•	—	•	•	•	—
Batteries...High capacity batteries (105 minutes)	—	•	—	—	—	•
Accu Power UL & CSA Approved Charger...115 volt AC, 36 volt DC, 21 amp fully automatic	—	•	—	—	—	•
Torque Converter...Automatic, variable speed, dry type with overdrive	•	—	•	•	•	—
STEERING/SUSPENSION						
Steering...Self-adjusting rack and pinion	•	•	•	•	•	•
Suspension...Front and rear tapered mono-leaf springs with dual hydraulic shocks	•	•	•	•	•	•
Brakes...Mechanical brake cable system to individual drum brakes on each rear wheel. Park brake is automatically released. Self adjusting multi-latch ratchet & pawl.	•	•	•	•	•	•
BODY/CHASSIS						
Frame Chassis...All aluminum	•	•	•	•	•	•
Rear Body...All aluminum	•	•	•	•	—	—
Front Body...Reaction injected molded polymer, color industrial gray	•	•	•	•	•	•
Paint...Two part synthetic enamel	•	•	•	•	•	•
Rear Body...Fiber reinforced plastic	—	—	—	—	•	•
Tires...18.00 x 8.5-8.00 Tubeless, 4-ply rated Load Range B	•	•	•	—	—	—
SEATING CAPACITY/FUEL CAPACITY						
Seating Capacity...2 persons. Seamless vinyl covered foam seats and backs	•	•	•	•	4 persons	4 persons
Fuel Tank...7.0 gal. U.S., regular or unleaded gasoline	•	—	•	•	•	—
DIMENSIONS						
Overall Length (Pickup/Flat Bed)	99"	99"	111"	114"/111"	100"	100"
Overall Width	50"	50"	50"	50"	47.25"	47.25"
Overall Height (without top)	46"	46"	46"	46"	46"	46"
Wheelbase	66.5"	66.5"	77.5"	77.5"	65.5"	65.5"
Ground Clearance	4.5"	4.5"	4.5"	4.5"	4.5"	4.5"
Front Wheel Tread	34.5"	34.5"	34.5"	34.5"	34.5"	34.5"
Rear Wheel Tread	38.5"	38.5"	38.5"	38.5"	38.5"	38.5"
Weight...Electric (without batteries)	—	533 lbs.	—	—	—	490 lbs.
Weight...Gasoline (dry) (Pickup/Flat Bed)	674 lbs.	—	713 lbs.	756/713 lbs.	633 lbs.	—
Forward Speed (gasoline governed)	12-14 mph	12-14 mph	14-16 mph	17-18 mph	12-14 mph	12-14 mph
Curb to Curb Clearance Circle	17'6"	17'6"	20'8"	20'8"	17'6"	17'6"
Turning Radius per SAE J 695	8.5'	8.5'	10'	10'	8.5'	8.5'
Intersecting Aisle Clearance	72"	72"	77"	77"	77"	77"
Braking Distance 12 mph (without load)	14'	14'	14'	29' at 18 mph	14'	14'
Floorboard Height	11.75"	11.75"	11.75"	11.75"	11.75"	11.75"
Load Bed Height	34.75"	34.75"	34.75"	34.75"	—	—
Load Bed Size 47" x 49.25" x 10.87" — 14.6 cu. ft. (box bed)	—	—	•	•	—	—
Load Bed Size 36" x 44.5" x 9.25" — 8.6 cu. ft. (box bed)	•	•	—	—	—	—
Vehicle Rated Capacity	800 lbs.	800 lbs.	1200 lbs.	1000 lbs.	—	—
Seat Height	29"	29"	29"	29"	29"	29"

CLUB CAR, INC., reserves the right to change specifications and designs at any time without notice and without incurring any obligation or liability whatsoever.

Carryall-I Optional Equipment

Optional Equipment Shown: (1) Lighting Package (High/Low Headlights, Taillights, Brake Lights and Horn), Lighting Package with Turn Signals; (2) Heavy Duty Front Bumper; (3) Wheel Covers; (4) Trailer Hitch; (6) Canopy Top; (7) State of Charge Meter; (8) Ashtray; (9) Stereo Radio; (10) Beverage Holders (2 or 4); (11) Rear View Mirrors (Regular or West Coast); (12) Custom Cab Assembly (Custom Cab Options include (13) Windshield Wiper, (14) Mirror(s), (15) Safety Strobe, (16) Solid Doors); (17) Portable Refreshment Center; (18) Snap-on Tinted Windshield; (19) Box Bed Kit

Optional Equipment Not Shown: Hour Meter, Front Cowl Accent Stripe, Weatherproof Enclosure, Driving Range Protective Enclosure, Custom Cab Options (Fan/Defogger, Dome Light, Vinyl Doors), Industrial Tires, Whitewall Tires, Extra Traction Tires, Flat Bed Kit, Stake Side Kit, Glove Compartment Door, Tailgate Chains, Pole Mount Strobe Light, LED Charger, Solid State Controller (CA-I Electric), 3.5 hp Motor (CA-I Electric), Ultra Power II Charger (CA-I Electric)

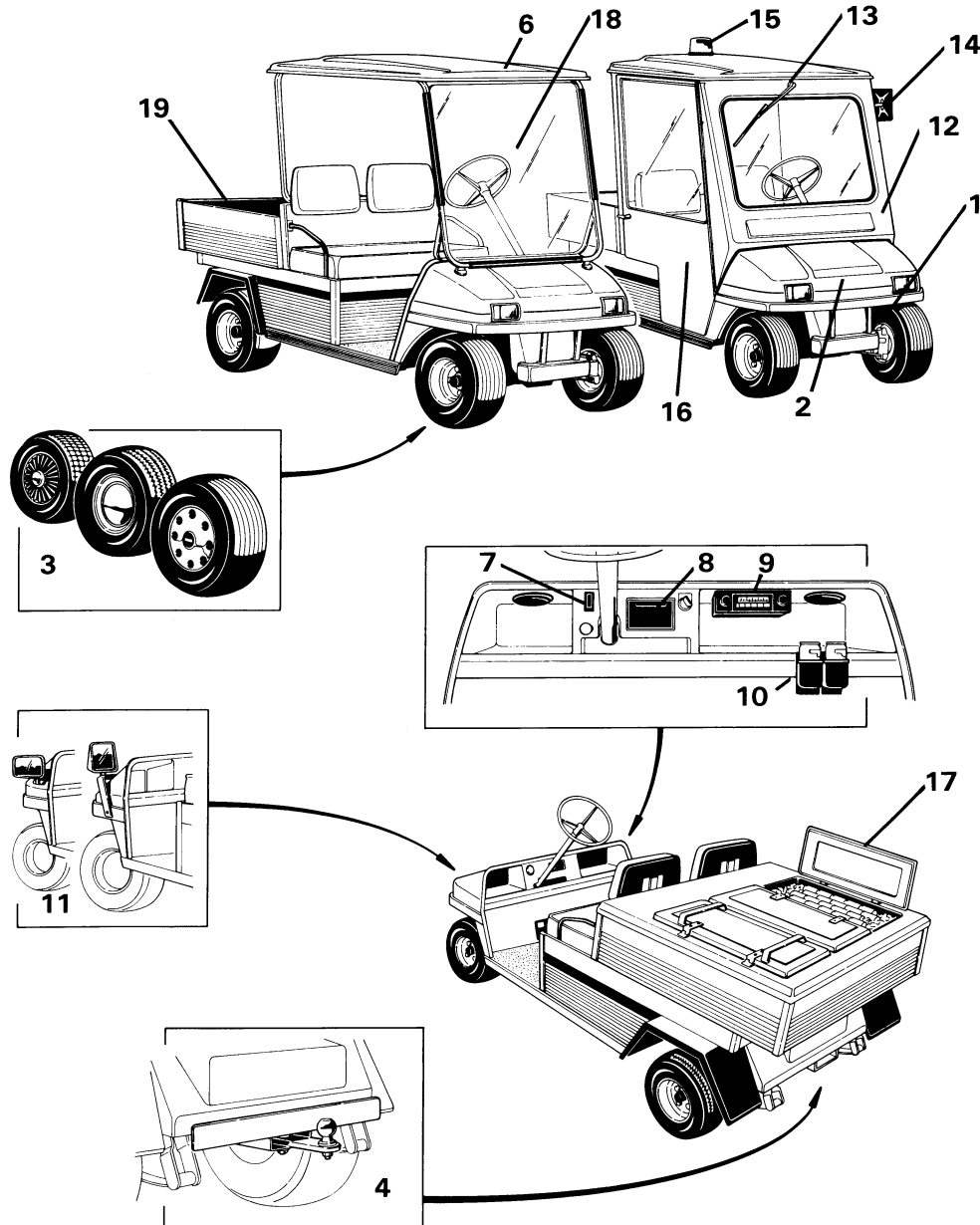

TOURALL OPTIONAL EQUIPMENT (Not Shown):

Major Options: Canopy Top (Special Options: Weatherproof Enclosure, Snap-on Tinted Windshield).

Other Options: Regular Rear View Mirror, West Coast Style Rear View Mirror, Wheel Covers, Tires — Industrial (5.70 x 8.00), Power Ribbed, Extra Traction, Lighting Package (High/Low Headlights, Taillights, Brakelights and Horn) (Deluxe Lighting Package includes Turn Signals), Stereo AM/FM Radio, Hour Meter, Extra Beverage Holder, Glove Box with Lock, Ashtray, Accent Stripe, I.D. Numbers, Heavy Duty Front Bumper.

Electric Vehicle Only: Ultra Power II (LED) Battery Charger, 3½ hp Motor, On Board Charger with Rewind Cord, Solid State Speed Controller, Extra Heavy Duty Batteries.

Carryall-II Optional Equipment

Optional Equipment Shown: (1) Lighting Package (High/Low Headlights, Taillights, Brake Lights and Horn), Lighting Package with Turn Signals; (2) Tailgate Ramp; (3) Rear View Mirrors (Regular or West Coast); (4) Wheel Covers; (5) Canopy Top; (6) Snap-On Tinted Windshield; (7) Beverage Holders (2 or 4); (8) Stereo Radio; (9) Ashtray; (10) Hydraulic Dump Unit; (12) Box Bed Kit

Optional Equipment Not Shown: Tool Box, Hour Meter, Front Cowl Accent Stripe, Safety Strobe Light, Safety Strobe Light with Post Mount, White Wall Tires, Industrial Tires, Extra Traction Tires, All Weather Enclosure, Stake Side Kit, Flat Bed Kit, Glove Compartment Door, Tailgate Chains, Driving Range Protective Enclosure, Custom Cab Assembly, Custom Cab Options (See Carryall-I)

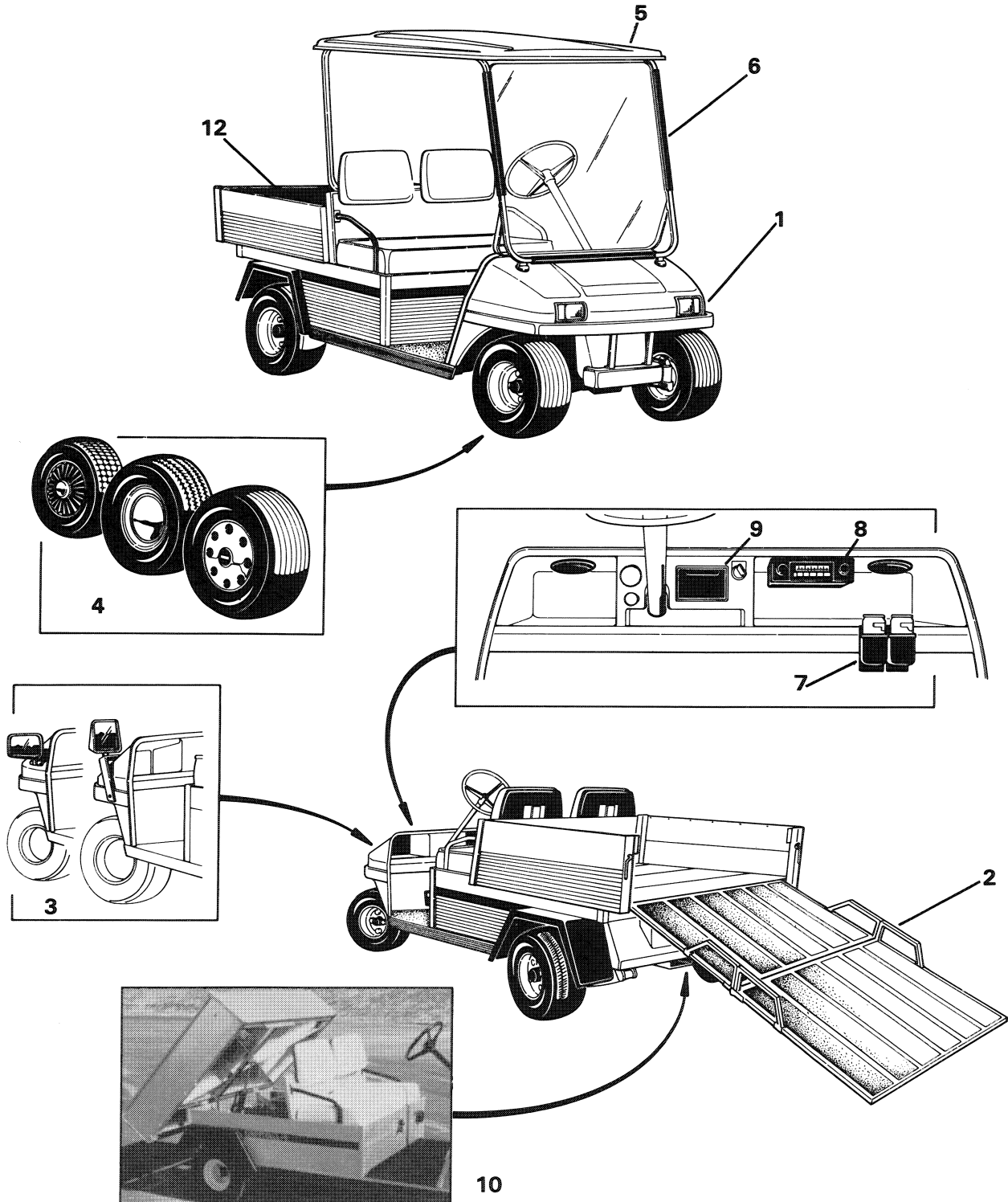

CLUB CAR LIMITED ONE (1) YEAR WARRANTY
Carryall or Tourall Vehicles

CLUB CAR, INC., "Manufacturer," warrants to the original retail purchaser that, subject to the terms and provisions contained herein, its new Carryall or Tourall vehicle, purchased from Manufacturer or an authorized dealer, is free from defects in materials and workmanship for a period of ONE (1) YEAR from the date of purchase, EXCEPT THOSE ITEMS SPECIFIED OTHERWISE BELOW.

LIMITED ONE (1) YEAR WARRANTY: The engine assembly, motor, transmission assembly, drive unit assembly, main frame assembly, hydraulic dump kit, Custom Cab Assembly, Driving Range Protective Enclosure and Portable Refreshment Center are warranted to be free from defects in materials and workmanship for a period of ONE (1) YEAR from the date of purchase.

LIMITED NINETY (90) DAY WARRANTY: All remaining components of the vehicle not specified otherwise are warranted to be free from defects in materials and workmanship for a period of NINETY (90) DAYS from the date of purchase.

This limited warranty covers materials, workmanship and repair labor cost as to those items specifically listed above for a period of ONE (1) YEAR from the date of purchase, or, as to all other items, NINETY (90) DAYS from the date of purchase. Such repair labor shall be performed only by Manufacturer, its authorized dealers, or a service agency approved by Manufacturer. IF THE WARRANTY REGISTRATION FORM IS NOT COMPLETED AND RETURNED TO CLUB CAR AT THE TIME OF THE ORIGINAL RETAIL SALE, PROOF OF DATE OF PURCHASE MUST BE PROVIDED WITH ANY WARRANTY CLAIM.

For further information or to present a warranty claim, contact: Warranty Administration, CLUB CAR, INC., P. O. Box 204658, Augusta, Georgia 30917-4658, U.S.A., (404) 863-3000.

ANY IMPLIED WARRANTY OF MERCHANTABILITY OR FITNESS FOR A PARTICULAR PURPOSE SHALL BE VOID AND EXCLUDED SUBSEQUENT TO THE EXPIRATION OF THE APPLICABLE LIMITED WARRANTY PERIOD OF TIME FROM THE DATE OF PURCHASE. THE REPLACEMENT OR REPAIR OF THE VEHICLE OR DEFECTIVE COMPONENT THEREOF IS THE EXCLUSIVE REMEDY UNDER THIS WRITTEN WARRANTY OR ANY IMPLIED WARRANTY. MANUFACTURER MAKES NO OTHER REPRESENTATION OR WARRANTY OF ANY KIND, AND NO REPRESENTATIVE, EMPLOYEE, DISTRIBUTOR OR DEALER OF MANUFACTURER, HAS THE AUTHORITY TO MAKE OR IMPLY ANY REPRESENTATION, PROMISE OR AGREEMENT WHICH IN ANY WAY VARIES THE TERMS OF THIS LIMITED WARRANTY.

LIMITED WARRANTY EXCLUSIONS

Without limiting the generality of the foregoing in any way, and as part of its limited warranty exclusions, Manufacturer does not warrant that its vehicle is suitable for use on any particular terrain or location. As in the operation of any vehicle, a prudent driver will read and study the Owner's Manual, learn the proper operation of the controls, obey all warnings, and exercise care and safe driving habits.

THE PROVISIONS OF THIS LIMITED WARRANTY SHALL NOT APPLY TO:

- (a) Normal maintenance services such as brake adjustments, steering and suspension adjustments, linkage adjustments, recommended lubrication, oil changes, and filter replacements;
- (b) Windows, battery wires and connectors, trim pieces, charger plugs and receptacles, decals, belts, filters, oils and lubricants, brake shoes, spark plugs, fuses, tubes, hoses, optional equipment and accessories, and batteries;
- (c) Tires, radios and battery charger (warranted solely through their respective manufacturers).

Any warranty service which includes labor must be performed by Manufacturer, its authorized dealers, or a service agency approved by Manufacturer.

THIS VEHICLE IS NOT DESIGNED OR INTENDED FOR USE ON PUBLIC STREETS, ROADS OR HIGHWAYS AND ANY SUCH USE RENDERS THE LIMITED WARRANTIES EXPRESSED HEREIN AND ALL IMPLIED WARRANTIES NULL AND VOID AND SAME ARE HEREBY EXCLUDED.

ALSO EXCLUDED FROM THIS LIMITED WARRANTY ARE ANY AND ALL INCIDENTAL OR CONSEQUENTIAL DAMAGES INCLUDING, BUT NOT LIMITED TO, LOSS OF USE, LOSS OF REVENUE, LOSS OF TIME, OR INCONVENIENCE. Some states do not allow limitations on how long an implied warranty lasts or the exclusion or limitation of incidental or consequential damages so the above limitations or exclusions may not apply to you.

WARRANTY LIMITATIONS

Manufacturer's sole liability shall be at its option to either replace or repair a defective vehicle or component thereof. Replacement shall mean furnishing a new vehicle or component thereof which is identical or reasonably equivalent to the warranted product at no cost to purchaser during the applicable limited warranty period of time. Repair shall mean remedying a defect in the vehicle or component thereof at no cost to the purchaser during the applicable limited warranty period of time. If Manufacturer elects to repair your vehicle, it may provide factory reconditioned parts or components. All parts and components replaced under warranty shall become the property of CLUB CAR.

Damage to a vehicle or component thereof not resulting from a defect or which occurs due to unreasonable or unintended use, improper installation of accessories, overloading, abuse or neglect (including failure to provide reasonable or necessary maintenance as outlined in the Owner's Manual), accident or alteration, including increasing the speed beyond factory specifications or modifications which affect the stability of the vehicle or the operation thereof, is excluded from the limited warranty.

This warranty gives you specific legal rights, and you may also have other rights which vary from state to state.

Practice Safety

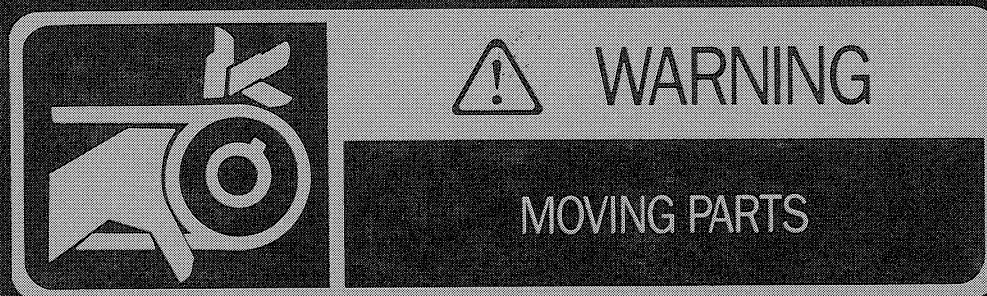

Safety signs like you see above may at first seem shocking. But compared to accidents they help prevent, they are not.

That's why Club Car urges you to always read and study the owner's manual before operating any vehicle. And pay close attention to the warnings in this manual and the safety signs on the vehicle you own.

At Club Car, we take your safety very seriously. Take time to understand the language of safety. It's a language that can save your life.



Club Car, Inc. / P. O. Box 204658

Augusta, Georgia 30917-4658 U.S.A. / 404-863-3000

© CLUB CAR, Inc., 1991